

家具



MUJI
無印良品

目錄 TABLE OF CONTENTS

收納家具 Storage Furniture

多用途鋼架 · 不銹鋼多用途鋼架.....4-7
Unit Shelf · Stainless Steel Unit Shelf

木製層架 · 木製抽屜.....9-12
Wooden Stacking Shelf · Wooden Stacking Chest

客廳 Living Room

木製組合櫃 · 木製櫃.....13-16
Wooden Stacking Cabinet · Wooden Cabinet

梳化.....18-21
Sofa

飯廳 Dining Room

節眼木製家具.....23
Wooden Furniture with Knots

橡木檯.....24
Oak Wood Table

橡木圓腳家具.....25
Oak Wood Round Legs Furniture

木製餐檯 · 木製餐椅.....26
Wooden Dining Table · Wooden Dining Chair

木製兩用家具.....27-28
Wooden Living Dining Furniture

IDÉE 家具 IDÉE Furniture

PUUF 豆袋梳化 · IDÉE 梳化 · IDÉE 桌子及家具.....29-32
PUUF Beads Sofa · IDÉE Sofa · IDÉE Table and Interior Accessories

書房 Study Room

橡木書檯.....33
Oak Wood Desk

寢室 Bedroom

小件家具.....34
Home Accessories

床架.....35-38
Bed

床褥.....39
Mattress

收納用品 Storage Unit

PP儲物 · PE儲物.....41-48
PP Storage · Soft PE Storage

椰纖編織儲物 · 藤織儲物.....49-50
Buri Storage · Rattan Storage

聚酯棉麻儲物.....51
Cotton Linen Polyester Storage

硬質紙儲物 · 鋼質工具箱.....52
Hard Pulp Storage · Steel Tool Box

不銹鋼儲物 · 鍍錫儲物.....53
Stainless Steel Storage · Tin Storage

亞加力儲物.....55-57
Acrylic Storage

PP文件格 · PP化妝品盛器.....58-59
PP File Box · PP Makeup Tray

小物整理用品.....60
Small Item Storage

硬質紙板儲物.....61
Cardboard Storage

MDF儲物.....62
MDF Storage

電子用品 Electrical Appliance

低噪音風扇.....63
Circulator Fan

家居電器.....64
Home Appliance

時鐘.....65-66
Clock



A4 適用於A4尺寸物件
Applicable to A4-sized items

 可配合多用途鋼架使用
Compatible with Unit Shelf

 可配合木製層架使用
Compatible with Wooden Stacking Shelf

 15 安裝所需時間 (分鐘)
Assembly time (mins)

 負重量
Loading

 建議最多可層疊數量
Maximum no. of stack

 安裝時需要十字螺絲批
Cross-head screwdriver is needed

 一人可完成安裝
Assembly by 1 person

 需兩人或以上完成安裝
Assembly by 2 persons or above



多用途鋼架 Unit Shelf

透過自由組合不同素材和尺寸的配件，即可組裝成用途廣泛的收納系統，例如作掛衣架、書檯或展示架等使用，整齊收納生活用品。



多用途鋼架的基本組合

以邊架及層板組成鋼架，並以交叉支架固定，即可成為基本款式的鋼架。安裝簡單，並能以每18.5厘米為間隔調節層板高度。

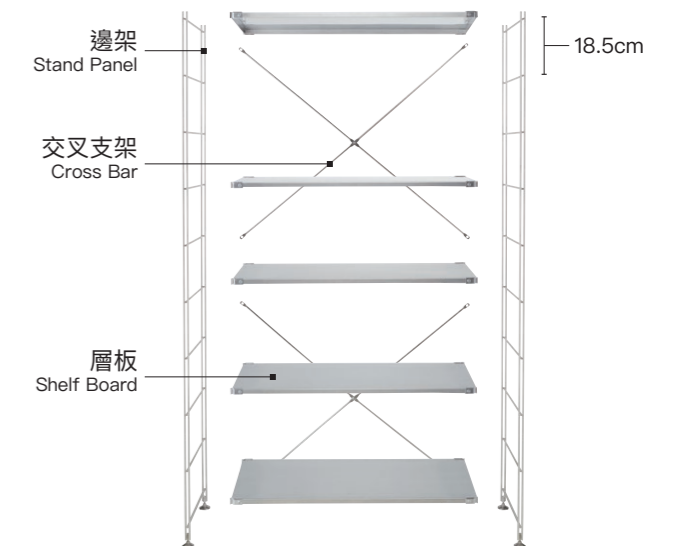

不銹鋼多用途鋼架套裝 Stainless Steel Unit Shelf Set



Wide Large
L86 x D41 x H175.5cm
▲100kg



Large
L58 x D41 x H175.5cm
▲100kg



Wide Medium
L86 x D41 x H120cm
▲75kg



Medium
L58 x D41 x H120cm
▲75kg



Wide Small
L86 x D41 x H83cm
▲50kg

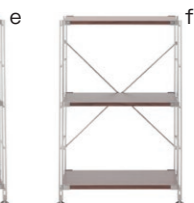

Small
L58 x D41 x H83cm
▲50kg



不銹鋼多用途鋼架套裝
Stainless Steel Unit Shelf Set

a	44911730	Wide Large	\$2900
b	44911365	Large	\$2500
	44911747	Wide Medium	\$2200
	44911372	Medium	\$2000
	44911853	Wide Small	\$1800
	44911389	Small	\$1600



橡木不銹鋼多用途鋼架套裝
Oak Wood Stainless Steel Unit Shelf Set

	44911426	Wide Large	\$2900
	44911396	Large	\$2500
c	44911433	Wide Medium	\$2200
d	44911402	Medium	\$2000
	44911440	Wide Small	\$1800
	44911419	Small	\$1600



胡桃木不銹鋼多用途鋼架套裝
Walnut Wood Stainless Steel Unit Shelf Set

	44911488	Wide Large	\$3000
	44911457	Large	\$2800
	44911495	Wide Medium	\$2400
	44911464	Medium	\$2200
e	44911501	Wide Small	\$1900
f	44911471	Small	\$1600

不銹鋼多用途鋼架 Stainless Steel Unit Shelf

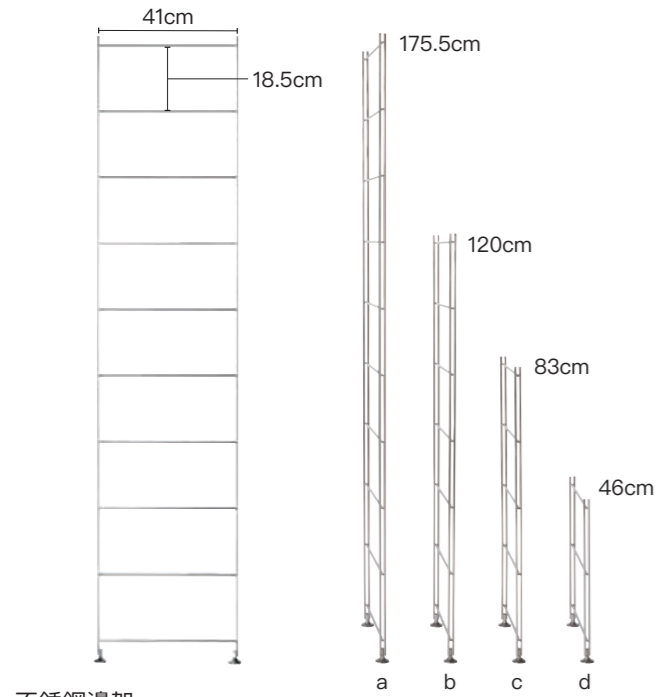

不銹鋼邊架
Stainless Steel Stand Panel

a [44911518]	H175.5cm	\$600	c [44911532]	H83cm	\$340
b [44911525]	H120cm	\$450	d [61179254]	H46cm	\$260



不銹鋼高度調整配件
Stainless Steel Height Adjust Parts

[76580850]	4pcs	\$90
------------	------	------

• 使用後，層板會升高約9.5cm



不銹鋼交叉支架
Stainless Steel Cross Bar

e [61179261]	L84cm	\$150
[61179278]	L42-56cm	\$120



窄層板
Narrow Board

f [37413917]	Oak	\$240
[37413924]	Walnut	\$280
[37413931]	Stainless Steel	\$340

L84 x D12cm
內寸：L79.5 x D12cm
▲5kg



木製角型層板
Wooden Corner Board

g [37413887]	Oak	\$650
[37413894]	Walnut	\$750

L80.5 x D80.5 x H1.8cm
內寸：
80cm
39.5cm
80cm
39.5cm
▲30kg



橡木層板
Oak Wood Board

[37167025]	L84cm	\$340
[37167032]	L56cm	\$260
[37167049]	L42cm	\$240

▲30kg



胡桃木層板
Walnut Wood Board

[37167056]	L84cm	\$380
[37167063]	L56cm	\$280
[37167070]	L42cm	\$260

▲30kg



鋼質層板 淺灰色
Steel Board Light Gray

[37414525]	L84cm	\$280
[37414532]	L56cm	\$240
[37414549]	L42cm	\$190

▲30kg



鋼質層板 深灰色
Steel Board Dark Gray

[37414488]	L84cm	\$280
[37414495]	L56cm	\$240
[37414501]	L42cm	\$190

▲30kg

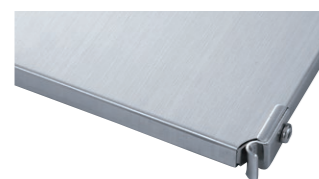

不銹鋼層板
Stainless Steel Board

[02998509]	L84cm	\$400
[02998516]	L56cm	\$340
[02998523]	L42cm	\$280

▲30kg

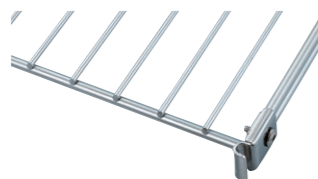

不銹鋼網狀層板
Stainless Steel Wire Shelf

[61179322]	L84cm	\$400
[61179339]	L56cm	\$340
[61179346]	L42cm	\$280

▲30kg

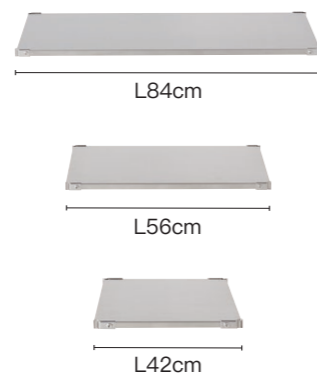

層板尺寸 Board Specification	
長度 Length	內寸 Inside Dimension
L84cm	L80cm x D39.5cm
L56cm	L52cm x D39.5cm
L42cm	L38cm x D39.5cm



鋼質邊板 小
Steel Side Panel S

[82141177]	Light Gray	\$120
a [76580904]	Dark Gray	\$120
[61179285]	Stainless Steel	\$240

L37.5 x D1.6 x H40cm



鋼質邊板 大
Steel Side Panel L

b [82141160]	Light Gray	\$180
[76581406]	Dark Gray	\$180
[37415386]	Stainless Steel	\$340

L37.5 x D1.6 x H58.5cm



不銹鋼掛衣桿
Stainless Steel Wardrobe Bar

c [61179797]	L84cm	\$180
[61179803]	L56cm	\$150



活輪
Castor

[61179780]	4pcs	\$90
------------	------	------

• 使用後，鋼架會升高約5.1cm
• 只適用於高度為120cm或以下的鋼架
• 兩個固定器
• 使用活輪後，鋼架的負重量將減半計算



鋼質背板 小
Steel Back Panel S

d [82141191]	Light Gray	\$120
[76581000]	Dark Gray	\$120

L56cm



鋼質背板 大
Steel Back Panel L

e [82141184]	Light Gray	\$150
[76580997]	Dark Gray	\$150

L84cm



鋼質背板 大
Steel Back Panel L

f [82141214]	Light Gray	\$180
[76580782]	Dark Gray	\$180

L56cm



鋼質背板 大
Steel Back Panel L

[82141207]	Light Gray	\$220
g [76580775]	Dark Gray	\$220

L84cm



木製兩層闊抽屜
Wooden Storage Case Wide 2 Drawers

h [82011319]	Oak	\$550
[02528546]	Walnut	\$650

L52 x D37 x H34.5cm
▲櫃面5kg / 抽屜各5kg



木製四層闊抽屜
Wooden Storage Case Wide 4 Drawers

i [82011357]	Oak	\$750
[02528676]	Walnut	\$850

L52 x D37 x H34.5cm
▲櫃面5kg / 抽屜各2kg



木製兩層抽屜
Wooden Storage Case 2 Drawers

[82011302]	Oak	\$450
j [02528539]	Walnut	\$550

L26 x D37 x H34.5cm
▲櫃面3kg / 抽屜各3kg



木製四層抽屜
Wooden Storage Case 4 Drawers

[82011340]	Oak	\$650
k [02528669]	Walnut	\$750

L26 x D37 x H34.5cm
▲櫃面3kg / 抽屜各1kg



木製儲物架
Wooden Storage Case Wide Open Type

l [82011364]	Oak	\$400
[02528683]	Walnut	\$500

L52 x D37 x H34.5cm
▲櫃面5kg / 底板5kg



不銹鋼鞏固鋼架配件
Stainless Steel Reinforcement Parts

m [76580874]	L84cm	\$220
--------------	-------	-------

內寸：L78 x D36cm



不銹鋼鞏固鋼架配件
Stainless Steel Reinforcement Parts

n [76580881]	L56cm	\$180
--------------	-------	-------

內寸：L50 x D36cm

鋼質多用途鋼架 Steel Unit Shelf

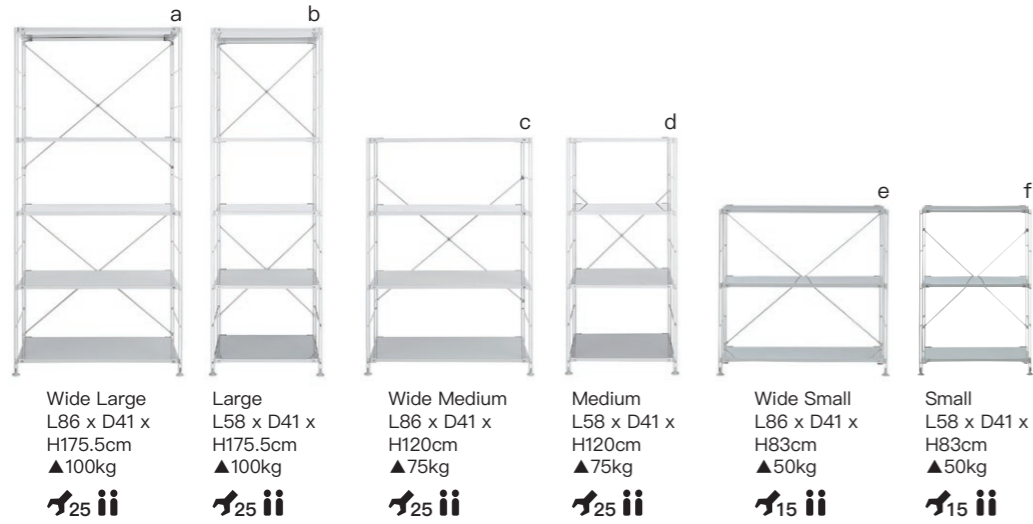

Wide Large L86 x D41 x H175.5cm ▲100kg
Large L58 x D41 x H175.5cm ▲100kg
Wide Medium L86 x D41 x H120cm ▲75kg
Medium L58 x D41 x H120cm ▲75kg
Wide Small L86 x D41 x H83cm ▲50kg
Small L58 x D41 x H83cm ▲50kg

鋼質多用途鋼架套裝 淺灰色 Steel Unit Shelf Set Light Gray

a [44911563] Wide Large \$1300
b [44911600] Large \$1200
c [44911570] Wide Medium \$980
d [44911617] Medium \$850
e [44911587] Wide Small \$850
f [44911624] Small \$750

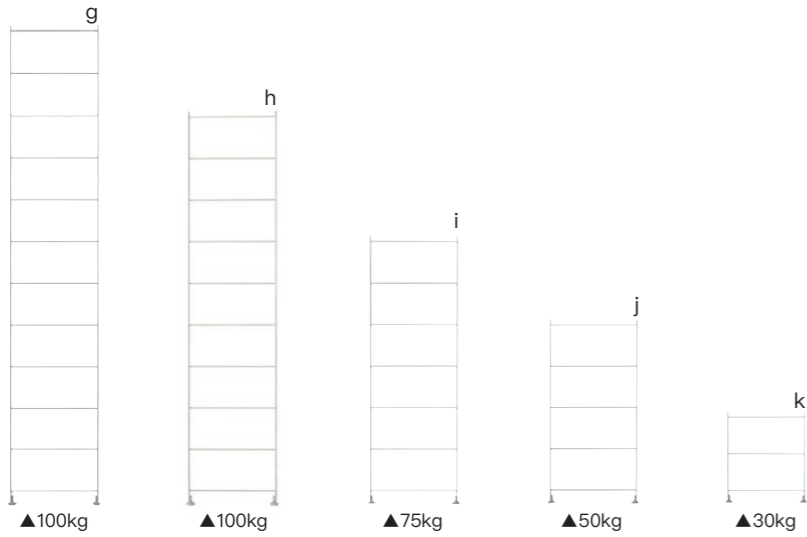

鋼質邊架 淺灰色 Steel Stand Panel Light Gray

g [44911686] H212.5cm \$290
h [44911679] H175.5cm \$200
i [44911662] H120cm \$190
j [44911655] H83cm \$150
k [02998363] H46cm \$90



鋼質層板 淺灰色 Steel Board Light Gray

[02998547] L84cm \$180
內寸：L80 x D39.5cm
[02998554] L56cm \$150
內寸：L52 x D39.5cm
[02998561] L42cm \$120
內寸：L38 x D39.5cm
▲30kg



鋼質高度調整配件 Steel Height Adjust Parts

[02998851] Light Gray 4pcs \$68
• 使用後，層板會升高約9.5cm



鋼質鞏固鋼架配件 Steel Reinforcement Parts

[02998813] L84cm \$120
內寸：L78 x D36cm
[02998820] L56cm \$80
內寸：L50 x D36cm

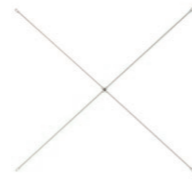

鋼質交叉支架 淺灰色 Steel Cross Bar Light Gray

[02998738] L84cm \$60
[02998745] L42-56cm \$55

多用途鋼架組件數量參考表

為了確保多用途鋼架的穩固性，請參考建議組件數量。

組件 Parts	邊架高度 Stand Panel Height	H212.5cm	H175.5cm	H120cm	H83cm	H46cm
層板 Board (L84 / 56 / 42cm)		4	3	3	2	3
交叉支架 Cross Bar		2	2	1	1	0

- 建議H212.5cm鋼質邊架須安裝防跌金屬扣以加強穩固度。由於未能提供鑽牆服務，故所有安裝服務均不包括安裝防跌金屬扣。不便之處，敬請見諒。
- 即使已安裝建議組件數量，多用途鋼架的穩固性仍有機會受組件安裝位置所影響。請確保層板及交叉支架安裝位置平均分佈，避免因鋼架上下或中間位置間距過大而造成搖晃。
- 邊板、窄層板及其他收納用品不可作為鞏固多用途鋼架之配件使用。
- 如以背板取代交叉支架或以鞏固鋼架配件取代層板，所需數量將因應不同組合而有所差異，詳情請向店員查詢。



木製層架 Wooden Stacking Shelf

層架可橫向或垂直擴展，並備有不同層數及闊度選擇，可按用途需要組合成書架、飾物架或家居間隔等各式收納家具，讓收納更靈活。



木製層架的基本組合

利用內附的鋼管將基本層架與連接架以縱向或橫向方式連接，即可組成理想的層架組合。另有闊身層架及開放式層架可供選擇，帶來更多樣化的組合。

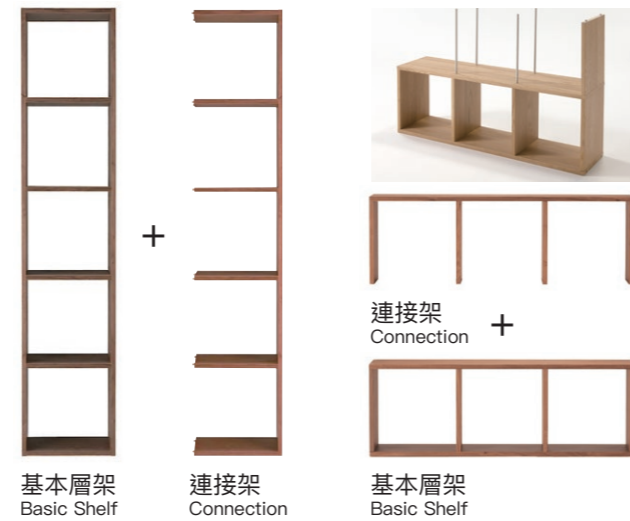

基本層架
Basic Shelf

連接架
Connection

基本層架
Basic Shelf

橡木 Oak Wood

側板及間隔板：橡木飾面木質纖維板
Natural Wood Laminated Fibre Board
(中空構造 Oak Veneer Flush Structure)

鋼管：鋼 Steel
表面塗層 (木部分)：亞加力樹脂塗層 Acrylic Resin Coating
表面塗層 (鋼管部分)：環氧聚酯混合樹脂粉塗裝 Epoxy Polyester
Mixed Resin Powder Coating

胡桃木 Walnut Wood

側板及間隔板：胡桃木飾面木質纖維板
Natural Wood Laminated Fibre Board
(中空構造 Walnut Veneer Flush Structure)

鋼管：鋼 Steel
表面塗層 (木部分)：亞加力樹脂塗層 Acrylic Resin Coating
表面塗層 (鋼管部分)：環氧聚酯混合樹脂粉塗裝 Epoxy Polyester
Mixed Resin Powder Coating

層板尺寸 Board Specification	
長度 Length	內寸 Inside Dimension
L42cm	L37.5 x D28.5 x H37.5cm
L81.5cm	L77 x D28.5 x H37.5cm

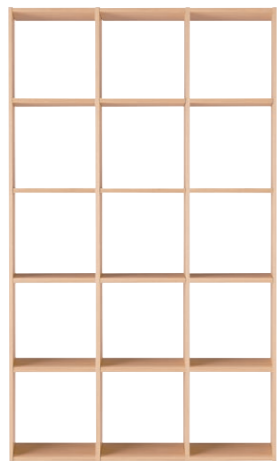

橡木五層架套裝
Oak Wood Stacking Shelf 5 Layers Set

38932253 5x3 Rows \$3680
L122 x D28.5 x H200cm
▲層板各20kg / 全體90kg



橡木三層架套裝
Oak Wood Stacking Shelf 3 Layers Set

38932277 3x3 Rows \$2980
L122 x D28.5 x H121cm
▲層板各20kg / 全體60kg



橡木三層架套裝
Oak Wood Stacking Shelf 3 Layers Set

38932284 3x2 Rows \$1980
L82 x D28.5 x H121cm
▲層板各20kg / 全體40kg

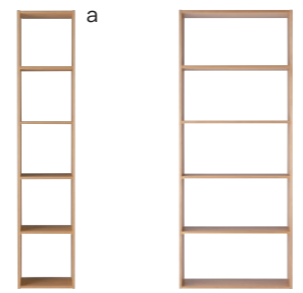

木製五層架
Wooden Stacking Shelf 5 Layers

a 38932116 Oak \$1850
38932314 Walnut \$2050
L42 x D28.5 x H200cm
▲層板各20kg / 全體60kg



木製五層闊架
Wooden Stacking Shelf Wide 5 Layers

b 38932178 Oak \$2450
38932376 Walnut \$2650
L81.5 x D28.5 x H200cm
▲層板各20kg / 全體60kg

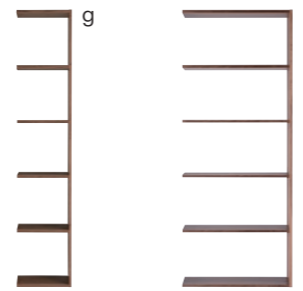

木製五層連接架
Wooden Stacking Shelf 5 Layers Connection

g 37263208 Oak \$1650
37265677 Walnut \$1850
L40 x D28.5 x H200cm



木製五層闊身連接架
Wooden Stacking Shelf Wide 5 Layers Connection

h 37263260 Oak \$2250
37265738 Walnut \$2450
L79.5 x D28.5 x H200cm



木製開放式5x3層架
Wooden Stacking Shelf 5x3 Additional Set

m 38932215 Oak \$2800
38932413 Walnut
L120 x D28.5 x H200cm
中央內寸: L116.5 x D28.5 x H116.5cm
▲上方全體20kg / 下方層板40kg

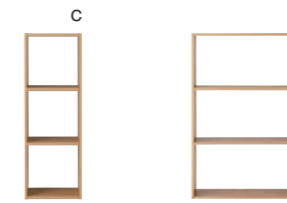

木製三層架
Wooden Stacking Shelf 3 Layers

c 38932109 Oak \$1450
38932307 Walnut \$1650
L42 x D28.5 x H121cm
▲層板各20kg / 全體40kg



木製三層闊架
Wooden Stacking Shelf Wide 3 Layers

d 38932161 Oak \$1950
38932369 Walnut \$2150
L81.5 x D28.5 x H121cm
▲層板各20kg / 全體40kg

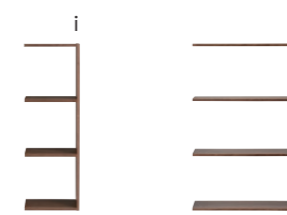

木製三層連接架
Wooden Stacking Shelf 3 Layers Connection

i 37263192 Oak \$1350
37265660 Walnut \$1550
L40 x D28.5 x H121cm



木製三層闊身連接架
Wooden Stacking Shelf Wide 3 Layers Connection

j 37263253 Oak \$1850
37265721 Walnut \$2050
L79.5 x D28.5 x H121cm



木製開放式5x2層架
Wooden Stacking Shelf 5x2 Additional Set

n 38932239 Oak \$2500
38932437 Walnut
L80 x D28.5 x H200cm
中央內寸: L77 x D28.5 x H116.5cm
▲上方全體20kg / 下方層板30kg

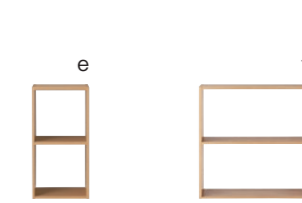

木製兩層架
Wooden Stacking Shelf 2 Layers

e 38932093 Oak \$1150
38932291 Walnut \$1350
L42 x D28.5 x H81.5cm
▲層板各20kg / 全體30kg



木製兩層闊架
Wooden Stacking Shelf Wide 2 Layers

f 38932154 Oak \$1650
38932352 Walnut \$1850
L81.5 x D28.5 x H81.5cm
▲層板各20kg / 全體30kg

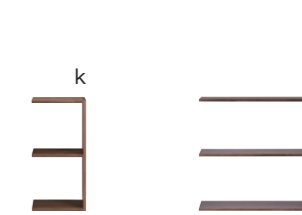

木製兩層連接架
Wooden Stacking Shelf 2 Layers Connection

k 37263185 Oak \$1050
37265653 Walnut \$1250
L40 x D28.5 x H81.5cm



木製兩層闊身連接架
Wooden Stacking Shelf Wide 2 Layers Connection

l 37263246 Oak \$1550
37265714 Walnut \$1750
L79.5 x D28.5 x H81.5cm



木製開放式5x2層架用連接板
Wooden Stacking Shelf 5x2 Additional Shelf

o 37263307 Oak \$800
37267046 Walnut \$1000
L78 x D28.5 x H40cm
▲頂板30kg



木製抽屜 Wooden Stacking Chest



木製單層抽屜 半型
Wooden Stacking Chest 1 Drawer Half

a [12381105] Oak \$250
[12381259] Walnut \$350
L37 x D28 x H18.5cm
▲主體5kg / 抽屜2kg ◎2



木製兩層抽屜 半型
Wooden Stacking Chest 2 Layers Half

b [12381204] Oak \$350
[12381198] Walnut \$450
L37 x D28 x H18.5cm
▲主體5kg / 抽屜3kg ◎2



木製兩格抽屜 半型
Wooden Stacking Chest 2 Drawers Half

c [02528515] Oak \$350
[02528522] Walnut \$450
L37 x D28 x H18.5cm
▲主體5kg / 抽屜3kg ◎2



木製層架 半型
Wooden Stacking Chest Open Type Half

d [12381242] Oak \$220
[12381235] Walnut \$320
L37 x D27 x H18.5cm
▲5kg ◎2



木製兩層抽屜
Wooden Stacking Chest 2 Layers

e [12381143] Oak \$450
[12381136] Walnut \$550
L37 x D28 x H37cm
▲主體5kg / 抽屜3kg ◎2



木製四層抽屜
Wooden Stacking Chest 4 Layers

f [12381228] Oak \$550
[12381211] Walnut \$650
L37 x D28 x H37cm
▲主體5kg / 抽屜2kg ◎2



木製四格抽屜
Wooden Stacking Chest 4 Drawers

g [12381167] Oak \$550
[12381150] Walnut \$650
L37 x D28 x H37cm
▲主體5kg / 抽屜2kg ◎2

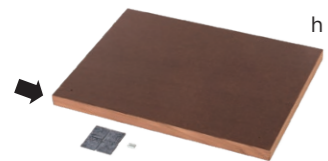

木製抽屜用底座
Wooden Board for Stacking Chest

h [02874346] Oak \$150
L37 x D27 x H2cm

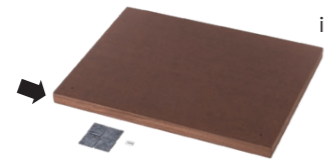

i [02874353] Walnut \$150
L37 x D27 x H2cm



連接螺絲
Joint Fitting Parts

[82854817] 2pcs \$20
• 加設連接螺絲後，可將兩個木製抽屜層疊使用

配合專用連接螺絲及底座，即可層疊兩個木製抽屜。
安裝方法：

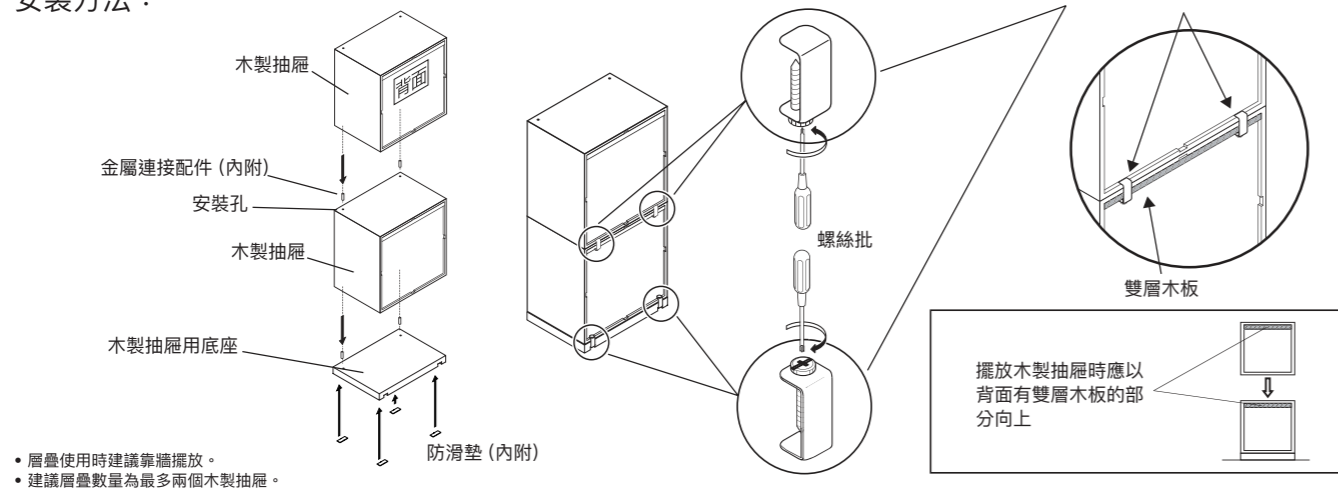

- 層疊使用時建議靠牆擺放。
- 建議層疊數量為最多兩個木製抽屜。

木製層架的組合方法 Assembling of Wooden Stacking Shelf

基本組合

只需按圖示以鋼管連接基本層架及連接架並裝上螺絲，即可完成安裝。透過組合不同層數與闊度的層架，自製個人化的收納家具。

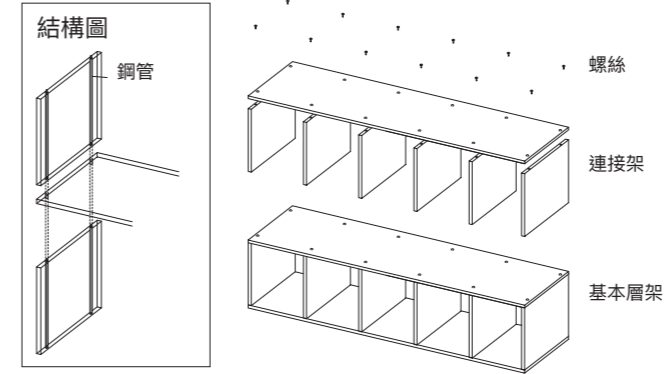

■ 計算負重量

層架組合整體負重量 = 組件負重量 x 組件數量 ÷ 2

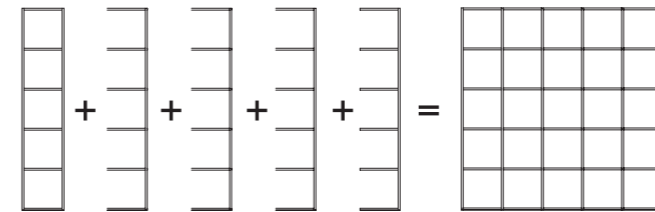

五層基本層架 x 1 + 五層連接架 x 4 (橫向組合)
負重量：60kg x 5個 ÷ 2 = 150kg

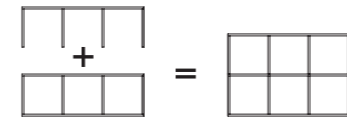

三層基本層架 x 1 + 三層連接架 x 1 (縱向組合)
負重量：40kg x 2個 ÷ 2 = 40kg

組合例子

■ 組合不同層數的層架

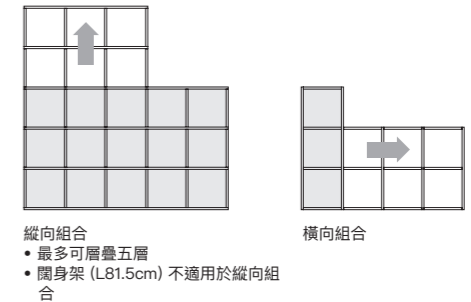

- 最多可層疊五層
- 闊身架 (L81.5cm) 不適用於縱向組合

■ 組合不同闊度的層架

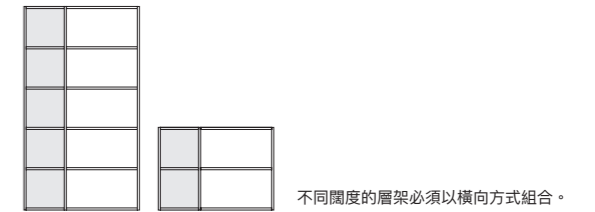

■ 以木製層架作間隔

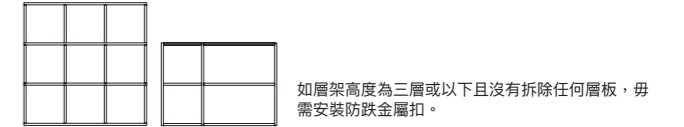

防跌金屬扣

- 每個基本層架均附有防跌金屬扣，如層架高度為四層或以上，建議安裝防跌金屬扣以加強穩固度。
- 由於需要進行鑽牆，所有安裝服務均不包括安裝防跌金屬扣。

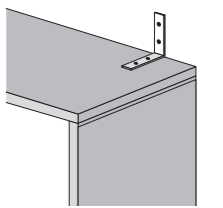

開放式組合

只需按圖示以鋼管連接基本層架及開放式層架並裝上螺絲，即可完成安裝。

■ 基本層架 + 開放式層架

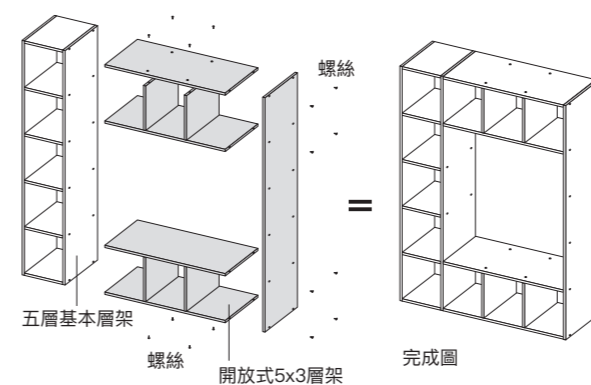

■ 基本層架 + 開放式層架 + 開放式層架連接板 + 連接架

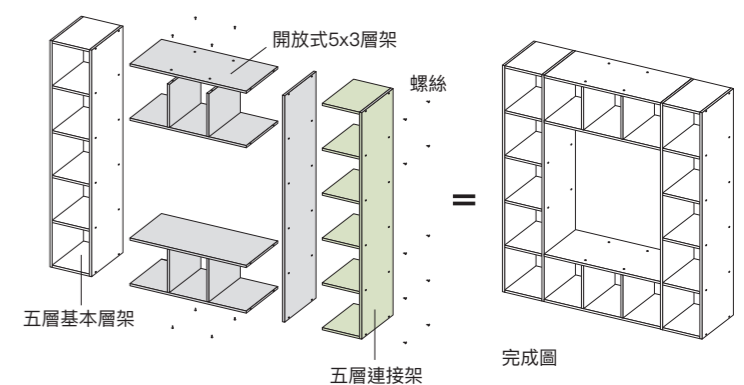

木製組合櫃 Wooden Stacking Cabinet

於基本的地櫃上安裝連接櫃、櫃門及抽屜等組件，成為能滿足個人收納需要的組合櫃。用途廣泛，可作電視櫃、書櫃、客廳或寢室儲物櫃等，收納各式生活用品。



木製組合櫃的基本組合

基本地櫃 頂板
Basic Cabinet Top Board

連接櫃
Connection

基本地櫃 主體
Basic Cabinet Body

分隔木板
Dividing Board

抽屜
Drawer

玻璃門
Glass Door

木門
Wooden Door

拆去地櫃頂板並裝上連接櫃。按用途選擇合適的配件。

組合成個人化的木製櫃。

<p>橡木 Oak Wood</p> <p>面板、側板及間隔板：橡木飾面木質纖維板 Natural Wood Laminated Fibre Board (中空構造 Oak Veneer Flush Structure)</p> <p>層板及底板：橡木飾面塑合板 Natural Wood Laminated Particle Board (Oak Veneer)</p> <p>鋼管：鋼 (Steel)</p> <p>腳：尼龍樹脂 (Nylon Resin)</p> <p>表面塗層 (木部分)：亞加力樹脂塗層 Acrylic Resin Coating</p> <p>表面塗層 (鋼管部分)：環氧聚酯混合樹脂粉塗裝 Epoxy Polyester Mixed Resin Powder Coating</p>	<p>胡桃木 Walnut Wood</p> <p>面板、側板及間隔板：胡桃木飾面木質纖維板 Natural Wood Laminated Fibre Board (中空構造 Walnut Veneer Flush Structure)</p> <p>層板及底板：胡桃木飾面塑合板 Natural Wood Laminated Particle Board (Walnut Veneer)</p> <p>鋼管：鋼 (Steel)</p> <p>腳：尼龍樹脂 (Nylon Resin)</p> <p>表面塗層 (木部分)：亞加力樹脂塗層 Acrylic Resin Coating</p> <p>表面塗層 (鋼管部分)：環氧聚酯混合樹脂粉塗裝 Epoxy Polyester Mixed Resin Powder Coating</p>
---	---

組合例子

 L82.5 x D39.5 x H165cm	 L82.5cm x D39.5 x H85cm	 L162.5 x D39.5 x H85cm
<p>橡木組合地櫃 x 1 \$1400</p> <p>橡木組合櫃用連接櫃 x 3 \$3600</p> <p>橡木組合櫃用木門 x 1 \$400</p> <p>橡木組合櫃用抽屜 x 2 \$800</p> <p>組合價 \$6200</p>	<p>橡木組合地櫃 x 1 \$1400</p> <p>橡木組合櫃用連接櫃 x 1 \$1200</p> <p>橡木組合櫃用抽屜 x 2 \$800</p> <p>橡木組合櫃用分隔木板 x 1 \$180</p> <p>組合價 \$3580</p>	<p>橡木組合地櫃 x 1 \$2200</p> <p>橡木組合櫃用連接櫃 x 1 \$1800</p> <p>橡木組合櫃用玻璃門 x 2 \$600</p> <p>橡木組合櫃用分隔木板 x 1 \$180</p> <p>組合價 \$4780</p>



木製組合地櫃 Wooden Stacking Cabinet

a	[38918073] Oak	\$2200
	[38918097] Walnut	\$2500
	L162.5 x D39.5 x H45cm	
	▲頂板65kg / 層板各5kg	

木製組合櫃用連接櫃 Wooden Stacking Cabinet Connection

	[38917908] Oak	\$1800
b	[38917977] Walnut	\$2000
	L162.5 x D39.5 x H40cm	

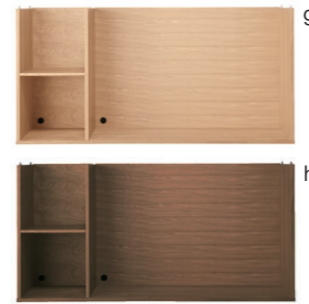

木製組合櫃用連接櫃 Wooden Stacking Cabinet Connection

g	[38917939] Oak	\$2500
h	[38917922] Walnut	\$2800
	L162.5 x D39.5 x H79.5cm	
	▲65kg	



木製組合櫃用抽屜 Drawer for Wooden Stacking Cabinet

l	[38917885] Oak	\$400
m	[38917953] Walnut	
	L77.5 x D37.5 x H17.5cm	
	內寸：L75 x D32.5 x H15.5cm	

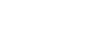

木製組合櫃連玻璃門 Wooden Stacking Cabinet Glass Door Set

p	[38931690] Oak	\$3200
	[38931720] Walnut	\$3500
	L162.5 x D39.5 x H45cm	



木製組合地櫃 Wooden Stacking Cabinet

c	[38918080] Oak	\$1400
	[38918103] Walnut	\$1500
	L82.5 x D39.5 x H45cm	
	▲頂板40kg / 層板各5kg	

木製組合櫃用連接櫃 Wooden Stacking Cabinet Connection

	[38917915] Oak	\$1200
d	[38917984] Walnut	
	L82.5 x D39.5 x H40cm	



木製組合櫃用書檯 Desk Unit for Wooden Stacking Cabinet

i	[38918042] Oak	\$3500
	[38918035] Walnut	\$3800
	L82.5 x D39.5 x H165cm	
	▲桌面40kg / 層板各5kg	

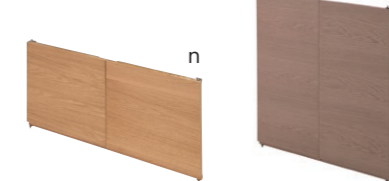

木製組合櫃用木門 Wooden Door for Wooden Stacking Cabinet

n	[38917878] Oak	\$400
	[38917946] Walnut	
	L38.5 x D2.5 x H36.5cm	
	[38918004] Oak	\$600
o	[38917991] Walnut	
	L38.5 x D2.5 x H76.5cm	

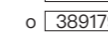

木製組合櫃連木門 Wooden Stacking Cabinet Wooden Door Set

q	[38931706] Oak	\$2800
	[38931737] Walnut	\$3200
	L162.5 x D39.5 x H45cm	



木製組合地櫃 高型 Wooden Stacking Cabinet High Type

e	[38918066] Oak	\$2500
	[38918059] Walnut	\$2800
	L82.5 x D39.5 x H85cm	
	▲頂板30kg / 層板各5kg	

木製組合櫃高型用連接櫃 Wooden Stacking Cabinet High Type Connection

	[38918028] Oak	\$2200
f	[38918011] Walnut	\$2500
	L82.5 x D39.5 x H79.5cm	

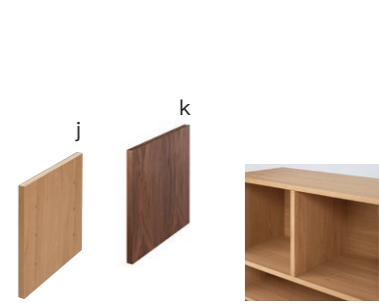

木製組合櫃用分隔木板 Dividing Board for Wooden Stacking Cabinet

j	[38917892] Oak	\$180
k	[38917960] Walnut	
	L37.5 x D2.5 x H37.5cm	



木製組合櫃用玻璃門 Glass Door for Wooden Stacking Cabinet

	[38917861] 1 Pair	\$300
	L38.5 x D0.5 x H36.5cm	

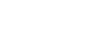

木製組合櫃 影音儲物組合 Wooden Stacking Cabinet AV Set

r	[38931713] Oak	\$6500
	[38931744] Walnut	\$7500
	L162.5 x D39.5 x H164.5cm	



木製櫃 Wooden Cabinet

以北美生產的橡木及胡桃木製成；採用統一深度，方便並排擺放不同款式，靈活運用於客飯廳、廚房、睡房等不同家居空間。底座為箱形設計，使用時更安穩，同時避免塵埃積聚。



<p>橡木 Oak Wood 本體：橡木飾面中密度纖維板 Natural Wood Laminated Medium Density Fibreboard (Oak Veneer) * 面板：橡木飾面塑合板 Natural Wood Laminated Particle Board (Oak Veneer) 層板：木紋飾面中密度纖維板 Printed Paper Decorative Medium Density Fibreboard 玻璃門：橡木 Natural Wood (Oak)、強化玻璃 Tempered Glass 表面塗層：氨基鉀酸酯樹脂塗層 Urethane Resin Coating * 窄身櫃適用</p>	<p>胡桃木 Walnut Wood 本體：胡桃木飾面中密度纖維板 Natural Wood Laminated Medium Density Fibreboard (Walnut Veneer) * 面板：胡桃木飾面塑合板 Natural Wood Laminated Particle Board (Walnut Veneer) 層板：木紋飾面中密度纖維板 Printed Paper Decorative Medium Density Fibreboard 玻璃門：胡桃木 Natural Wood (Walnut)、強化玻璃 Tempered Glass 表面塗層：氨基鉀酸酯樹脂塗層 Urethane Resin Coating * 窄身櫃適用</p>
--	--

<p>木製雙門櫃 Wooden 2 Doors Cabinet</p> <p>a <input type="checkbox"/> 12851615 Oak \$3280 <input type="checkbox"/> 12851530 Walnut \$3580 L88 x D44 x H83cm 30 ii</p>	<p>木製窄身櫃 Wooden Narrow Cabinet</p> <p>b <input type="checkbox"/> 12851608 Oak \$1880 <input type="checkbox"/> 12851523 Walnut \$2180 L44 x D44 x H83cm 25 ii</p>	<p>木製四層櫃 Wooden Chest 4 Layers</p> <p>c <input type="checkbox"/> 12851592 Oak \$3080 <input type="checkbox"/> 12851516 Walnut \$3580 L88 x D44 x H83cm</p>
--	---	---

<p>木製玻璃雙門櫃 Wooden 2 Doors Window Cabinet</p> <p>d <input type="checkbox"/> 12851479 Oak \$3080 <input type="checkbox"/> 12851554 Walnut \$3580 L88 x D44 x H83cm 30 ii</p>	<p>木製玻璃窄身櫃 Wooden Window Narrow Cabinet</p> <p>e <input type="checkbox"/> 12851462 Oak \$1880 <input type="checkbox"/> 12851547 Walnut \$2180 L44 x D44 x H83cm 25 ii</p>	
---	--	--

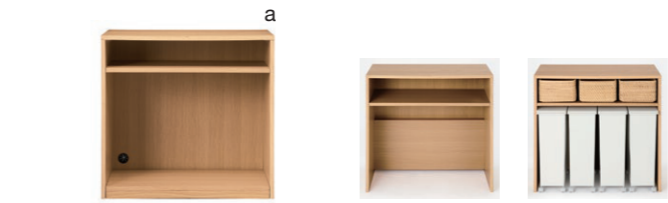

木製多用途儲物架
Wooden Multi Purpose Shelf

a 12851486 Oak \$2080
 12851561 Walnut \$2280
L88 x D44 x H83cm
25 ii

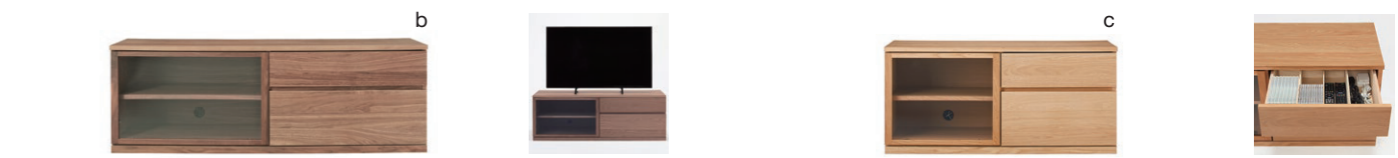

木製電視櫃
Wooden AV Rack

b 12851509 Oak \$3580
 12851585 Walnut \$4280
L150 x D44 x H50.5cm

c 12851493 Oak \$3280
 12851578 Walnut \$3580
L110 x D44 x H50.5cm

<p>橡木 Oak Wood 本體：橡木飾面中密度纖維板 Natural Wood Laminated Medium Density Fibreboard (Oak Veneer) 層板：木紋飾面塑合板 Printed Paper Decorative Particle Board 玻璃門：橡木 Natural Wood (Oak)、強化玻璃 Tempered Glass 表面塗層：氨基鉀酸酯樹脂塗層 Urethane Resin Coating</p>	<p>胡桃木 Walnut Wood 本體：胡桃木飾面中密度纖維板 Natural Wood Laminated Medium Density Fibreboard (Walnut Veneer) 層板：木紋飾面塑合板 Printed Paper Decorative Particle Board 玻璃門：胡桃木 Natural Wood (Walnut)、強化玻璃 Tempered Glass 表面塗層：氨基鉀酸酯樹脂塗層 Urethane Resin Coating</p>
--	--

<p>橡木趟門電視櫃 Oak Wood AV Rack Flat Type with Sliding Door</p> <p><input type="checkbox"/> 82392623 \$2200 L150 x D35 x H36.5cm</p>	<p><input type="checkbox"/> 82392616 \$1900 L110 x D35 x H36.5cm</p>
---	--

<p>面板、底板及門：橡木飾面中密度纖維板 Natural Wood Laminated Medium Density Fibreboard (中空構造 Oak Veneer Flush Structure)</p> <p>側板：橡木飾面塑合板 Natural Wood Laminated Particle Board (Oak Veneer)</p> <p>內側板及背板：木紋飾面中密度纖維板 Printed Paper Decorative Medium Density Fibreboard</p>	<p>層板：合成樹脂塑合板 Synthetic Resin Laminated Particle Board (三聚氰胺樹脂 Melamine Resin)</p> <p>腳：橡木飾面中密度纖維板 Natural Wood Laminated Medium Density Fibreboard (Oak Veneer)</p> <p>輔助腳：橡膠木 Natural Wood (Rubber Wood)</p> <p>表面塗層 (木部分)：亞加力樹脂塗層 Acrylic Resin Coating</p> <p>表面塗層 (輔助腳)：氨基鉀酸酯樹脂塗層 Urethane Resin Coating</p>
--	--

木製梳化 Sofa Wooden Frame

採用木材為梳化主體，為家居帶來溫暖感覺。座墊備有羽毛袋裝彈簧及低反彈袋裝彈簧兩種物料供選擇，讓你按喜愛坐感自由組合。易於安裝及拆卸，移動時更感輕鬆。



羽毛袋裝彈簧木製梳化
Sofa Wooden Frame Feather Pocket Coil

12396765	3 Seats	\$6980
L210 x D96 x H82.5cm 座面尺寸: L184 x D54 x H42.5cm		
a 12396758	2.5 Seats	\$5980
L178.5 x D96 x H82.5cm 座面尺寸: L152.5 x D54 x H42.5cm		
12396741	2 Seats	\$4980
L148 x D96 x H82.5cm 座面尺寸: L122 x D54 x H42.5cm		

 **30 ii**
• 梳化必須連同梳化套一併使用。
Sofa must be used together with a cover.

低反彈袋裝彈簧木製梳化
Sofa Wooden Frame Urethane Pocket Coil

12396796	3 Seats	\$6800
L210 x D96 x H82.5cm 座面尺寸: 184 x D54 x H42.5cm		
12396789	2.5 Seats	\$5800
L178.5 x D96 x H82.5cm 座面尺寸: L152.5 x D54 x H42.5cm		
b 12396772	2 Seats	\$4800
L148 x D96 x H82.5cm 座面尺寸: L122 x D54 x H42.5cm		

 **30 ii**
• 梳化必須連同梳化套一併使用。
Sofa must be used together with a cover.

框架 Wooden Frame







手把: 天然橡木材
背板、座面: 天然橡木夾板
結構: 夾板
表面加工: 聚氨酯樹脂塗裝
座面: 橡膠帶

梳化坐墊 Cushion

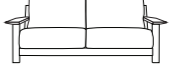
「羽毛袋裝彈簧」靠墊: 聚酯纖維、棉
填充物: (背靠坐墊) 羽毛、聚氨酯泡沫、聚酯纖維棉
(坐墊) 羽毛、聚氨酯泡沫、聚酯纖維棉、鋼製螺旋狀彈簧
「低反彈袋裝彈簧」靠墊: 聚酯纖維、棉
填充物: (背靠坐墊) 聚氨酯泡沫、聚酯纖維棉
(坐墊) 聚氨酯泡沫、聚酯纖維棉、鋼製螺旋狀彈簧

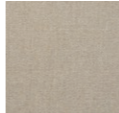
梳化木架可分成四件，方便搬遷時移動。



物料 Material	梳化套尺寸 Sofa Cover Size	3座位 3 Seats	2.5座位 2.5 Seats	2座位 2 Seats
				
羽毛袋裝彈簧梳化坐墊用 For Feather Pocket Coil Cushion				
綿帆布 Cotton Canvas  Light Gray  Melange Beige		\$1980 44620670 Light Gray 44620656 Melange Beige	\$1580 44620649 Light Gray 44620618 Melange Beige	\$1280 44620601 Light Gray 44620588 Melange Beige
	低反彈袋裝彈簧梳化坐墊用 For Urethane Pocket Coil Cushion			
		\$1980 44620571 Light Gray 44620557 Melange Beige	\$1580 44620540 Light Gray 44620526 Melange Beige	\$1280 44620502 Light Gray 44620489 Melange Beige
羽毛袋裝彈簧梳化坐墊用 For Feather Pocket Coil Cushion				
綿麻 Cotton Linen  Ecru  Beige		\$2280 44512814 Ecru 44512876 Beige	\$1980 44512807 Ecru 44512869 Beige	\$1780 44512791 Ecru 44512852 Beige
	低反彈袋裝彈簧梳化坐墊用 For Urethane Pocket Coil Cushion			
		\$2280 44512784 Ecru 44512845 Beige	\$1980 44512777 Ecru 44512838 Beige	\$1780 44512760 Ecru 44512821 Beige
低反彈袋裝彈簧梳化坐墊用 For Urethane Pocket Coil Cushion				
棉質牛仔布 Cotton Denim  Navy		\$1980 44511084 Navy	\$1580 44511077 Navy	\$1280 44511060 Navy

低反彈袋裝彈簧梳化 Urethane Pocket Coil Sofa

採用低反彈聚氨酯製成，硬度適中，帶來安定的坐感。扶手位置及高度經細心考量，可輕鬆安放手臂或作背靠使用，適合不同坐臥姿勢。



低反彈袋裝彈簧寬手把2.5座位梳化
Urethane Pocket Coil Wide Armrest 2.5 Seats Sofa

82846218 \$5000

L193 x D90.5 x H70cm



- 梳化必須連同梳化套一併使用。
Sofa must be used together with a cover.
- 此梳化不包括家具用腳。
Legs for Furniture are not included with this sofa item.



低反彈袋裝彈簧寬手把2座位梳化
Urethane Pocket Coil Wide Armrest 2 Seats Sofa

82846201 \$4280

L162 x D90.5 x H70cm



- 梳化必須連同梳化套一併使用。
Sofa must be used together with a cover.
- 此梳化不包括家具用腳。
Legs for Furniture are not included with this sofa item.



座墊：袋裝彈簧 + 聚氨酯



背墊：聚氨酯



家具用腳
Legs for Furniture

d 02528867 Wooden Natural 02529406 Wooden Natural \$200

e 02528874 Wooden Brown 02529413 Wooden Brown

f 02528881 Steel Black 02528898 Steel Black
Dia6 x H10cm 4pcs Dia6 x H12cm 4pcs



物料 Material	梳化套尺寸 Sofa Cover Size	2.5座位 2.5 Seats	2座位 2 Seats
棉質平織 Cotton Plain Dark Brown			 \$1800 82072655 Dark Brown
棉質聚酯纖維 Cotton Polyester Brown		\$2180 82074444 Brown	
棉質 Cotton Thick Dark Brown		\$2180 82078428 Dark Brown	
棉質牛仔布 Cotton Denim Blue Navy		\$2180 82074956 Blue 82075120 Navy	\$1800 82074963 Blue

真皮梳化 Leather Sofa

呈現皮革的天然質感與柔軟度；堅固耐用的內層構造，令梳化能夠長久使用而不易變形。



真皮羽絨低反彈袋裝彈簧2.5座位梳化
Leather Feather PocketCoil 2.5 Seats Sofa

a 82844481 Ivory \$14000

82844535 Brown

82844580 Black

L193 x D90.5 x H70cm



- 此梳化不包括家具用腳。
Legs for Furniture are not included with this sofa item.



真皮羽絨低反彈袋裝彈簧2座位梳化
Leather Feather PocketCoil 2 Seats Sofa

82844474 Ivory \$12000

82844528 Brown

b 82844573 Black

L162 x D90.5 x H70cm



- 此梳化不包括家具用腳。
Legs for Furniture are not included with this sofa item.

表面塗層

真皮梳化套帶有保護塗層有助避免沾上污漬及刮花，同時能保留皮革原有的良好透氣度、彈性及伸縮性。

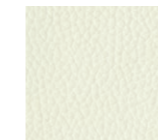

Ivory

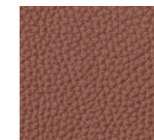

Brown

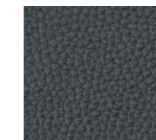

Black



家具用腳
Legs for Furniture

d 02528867 Wooden Natural 02529406 Wooden Natural \$200

e 02528874 Wooden Brown 02529413 Wooden Brown

f 02528881 Steel Black 02528898 Steel Black
Dia6 x H10cm 4pcs Dia6 x H12cm 4pcs

提升舒適度及耐用度

皮革厚度達1.5mm，令梳化不易變形。表面加上保護塗層，提升耐用度同時保持皮革原有的質感。背墊及座墊加入聚氨酯及羽絨製成，帶來更舒適的坐感。



背墊：聚氨酯 + 羽絨 (混羽毛)



座墊：聚氨酯 + 羽絨 (混羽毛) + 袋裝彈簧



舒適豆袋梳化 Beads Sofa

以微細粒子作填充物，能因應身體姿勢變化提供柔軟承托；配合以彈性素材及帆布兩種物料製成的梳化套，能隨着擺放方式呈現不同形態，令你無論靠坐或躺臥時均可感到放鬆舒適。



橫放坐臥

柔軟承托頭部至腰間，讓閱讀或觀看電視時舒適靠坐。

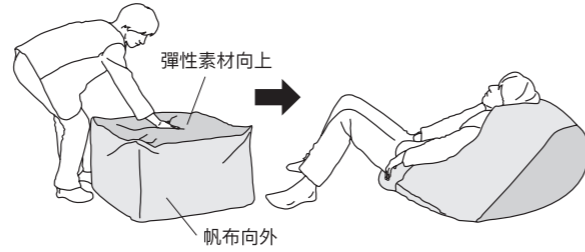

豎放躺臥

躺臥時梳化向外伸展，承托全身，適合小睡休息。

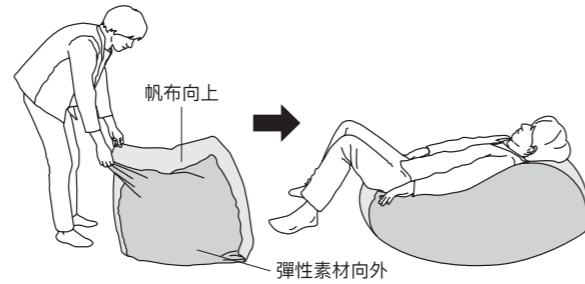

新價格
\$

舒適豆袋梳化 Beads Sofa

37244955 \$980 → \$750

L65 x D65 x H43cm
彈性素材：100% 聚酯纖維 (Polyester)
填充物：0.5mm 聚苯乙烯珠粒 (Polystyrene Beads)

- 豆袋梳化必須連同梳化套一併使用。
Beads Sofa must be used together with a cover.
- 小童必須在家長陪同下方可使用此產品，以免發生危險。
For safety reasons, children must be accompanied by parents when using the product.



新價格
\$

舒適豆袋梳化套 Beads Sofa Cover

棉質 Cotton \$280 → \$228
82960518 Ecu 82960532 Gray 37244979 Beige
37461468 Charcoal Gray 82960525 Brown 82960549 Navy

棉質牛仔布 Cotton Denim \$430 → \$288
44648322 Hickory Denim 82960556 Navy Denim
L65 x D65 x H43cm
彈性素材：100% 聚酯纖維 (Polyester) · 帆布：100% 棉 (Cotton)



新價格
\$

舒適豆袋梳化用承托座墊 Beads Sofa Replenishing Cushion

44528686 \$320 → \$188



迷你舒適豆袋梳化套裝 Mini Beads Sofa Set

棉質牛仔布 Cotton Denim \$680
44648346 Hickory Denim 44214985 Navy Denim
L45 x D45 x H33cm
彈性素材：100% 聚酯纖維 (Polyester) · 帆布：100% 棉 (Cotton)
填充物：0.5mm 聚苯乙烯珠粒 (Polystyrene Beads)



節眼木製家具 Wooden Furniture with Knots

樹木和人一樣，每棵樹都帶有不同特徵和個性。每棵樹木都是獨特而不帶重複的。產品由實木製成，可以長時間使用，同時享受木材隨著時間的推移而發生的變化。



木材顏色的差異

即使同一類型的樹木也會有不同。本產品由多塊實木塊拼接製成，以充分使用樹木原料，因此會出現拼接部分，以及木材顏色可能有差異。

橡木 Oak Wood



胡桃木 Walnut Wood

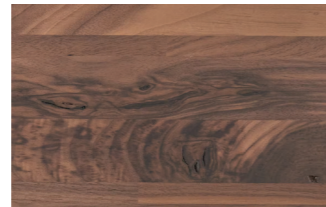

節眼木製餐檯連抽屜 Wooden Table With Drawers with Knots

a	12922902	Oak	\$6880	b	12922919	Oak	\$5880	c	12922926	Oak	\$4280
	12922971	Walnut	\$8880		12922988	Walnut	\$6880		12922995	Walnut	\$4880
	L180 x D80 x H72cm				L140 x D80 x H72cm				L80 x D80 x H72cm		
	🔧 20 ii				🔧 20 ii				🔧 20 ii		



節眼木製長檯 Wooden Bench with Knots

12922889	Oak	\$2280
L100 x D37 x H44cm		



節眼木製角几 Wooden Side Table with Knots

12922896	Oak	\$980
L37 x D37 x H44cm		



橡木檯 Oak Wood Table

檯面板及檯腳備有多種尺寸供自由組合選用，照顧不同室內空間所需。



設計簡潔，沒有多餘裝飾，呈現桌子的基本功能；安裝簡易，只需將檯腳嵌入桌面板即可。

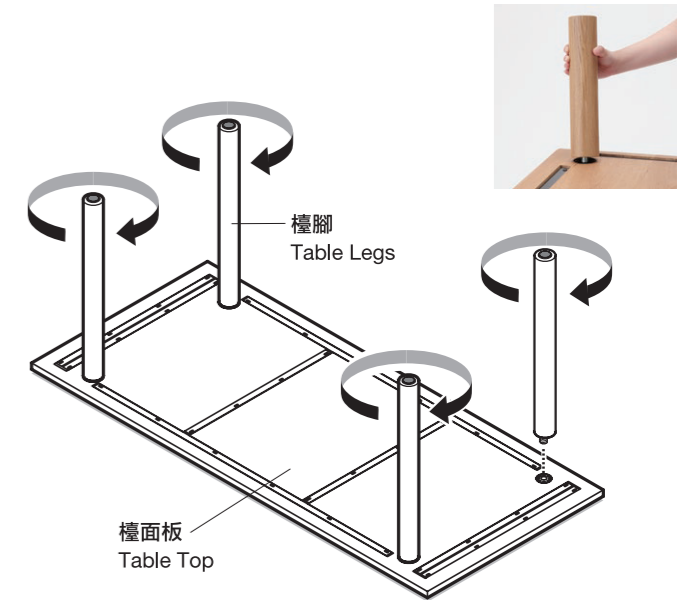

橡木檯面板 Oak Wood Table Top

a	44877128	\$980
L80 x D40cm		
	44877142	\$1580
L80 x D80cm		
	44877135	\$1580
L120 x D60cm		
	44877159	\$2980
L140 x D80cm		
	44877166	\$3480
L180 x D80cm		

橡木檯腳 Oak Wood Table Legs Set of 4

	82586152	\$800
Dia6.5 x H35cm 4pcs		
b	82586176	\$1000
Dia6.5 x H72cm 4pcs		

檯面板：L180 x D80cm 檯腳：H72cm 組合價 \$4480	檯面板：L140 x D80cm 檯腳：H72cm 組合價 \$3980	檯面板：L120 x D60cm 檯腳：H72cm 組合價 \$2580	檯面板：L80 x D80cm 檯腳：H35cm 組合價 \$2380	檯面板：L80 x D40cm 檯腳：H35cm 組合價 \$1780

橡木圓腳家具 Oak Wood Round Legs Furniture

採用品質良好的橡木為素材，並由日本的熟練工匠製成。帶有天然木紋及色調，呈現木材原有的樸實質感。材質堅固厚實，令家具更耐用。



橡木圓腳餐檯 大
Oak Wood Round Legs Table L

15901999 \$10500

L180 x D85 x H72cm
檯面：積層合板 (Medium Density Fiberboard)、
橡木薄板 (Oak Wood Veneer)
檯腳：橡木 (Oak Wood Solid Board)、聚氨酯樹脂塗層 (Polyurethane)



橡木圓腳餐檯 小
Oak Wood Round Legs Table S

15901982 \$8800

L150 x D80 x H72cm
檯面：積層合板 (Medium Density Fiberboard)、
橡木薄板 (Oak Wood Veneer)
檯腳：橡木 (Oak Wood Solid Board)、聚氨酯樹脂塗層 (Polyurethane)



橡木圓腳餐椅
Oak Wood Round Legs Arm Chair

15902040 \$3380

L55.5 x D50.5 x H73cm
座面：H44.5cm
主體：橡木 (Oak Wood Solid Board)
聚氨酯樹脂塗層 (Polyurethane)



橡木圓腳長凳
Oak Wood Round Legs Bench

02065959 \$4080

L100 x D34 x H44cm
主體：橡木 (Oak Wood Solid Board)
聚氨酯樹脂塗層 (Polyurethane)



橡木圓腳凳
Oak Wood Round Legs Stool

02065966 \$2580

L52.5 x D34 x H44cm
主體：橡木 (Oak Wood Solid Board)
聚氨酯樹脂塗層 (Polyurethane)

木製餐檯 · 木製餐椅 Wooden Dining Table · Wooden Chair



木製圓腳伸縮餐檯
Wooden Round Legs Extendable Table

a 82009231 Oak \$8000
82049541 Walnut \$9500

L149-220 x D85 x H72cm

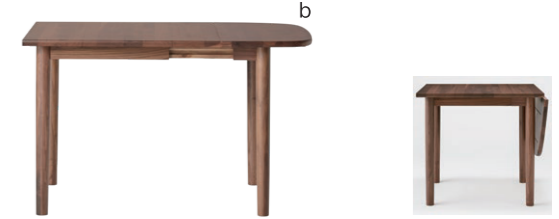

b 82009248 Oak \$5780
82049558 Walnut \$8500

L84.5-120 x D80 x H72cm



橡木圓腳座椅
Oak Wood Round Chair

c 82009255 Natural \$1180
d 44617205 Brown \$1580

L45 x D51 x H77cm
座面：H42cm



木製圓腳軟墊座椅
Wooden Cloth Seat Round Chair

e 82009286 Oak \$1580
f 15242122 Walnut \$1880

L45 x D51 x H77cm
座面：H44cm



木製座椅連座墊
Wooden Chair with Seat Cushion

g 44503041 Oak \$880

h 44503058 Walnut \$1180
L38 x D48.5 x H79cm
座面：H45.5cm



木製軟墊座椅
Wooden Cloth Seat Chair

i 82502862 Oak \$850

j 82502879 Walnut \$980
L43 x D55 x H81cm
座面：H45cm



棉帆布軟墊座椅套
Cotton Canvas Cover For Chair

k 44617205 Beige \$280

l 44617236 Light Gray

• 需另購椅套。
Seat cover is not included.

木製兩用家具 Wooden Living Dining Furniture

客飯廳兩用的家具，讓你按家居間隔，靈活運用空間。兩用檯高度較低，有助擴闊空間感；兩用座椅則座面寬闊舒適，可加裝扶手或連接兩張座椅作梳化使用。



木製兩用檯 大
Wooden Living Dining Table L

- 新價格**
- 38727798 Oak \$3580 → \$2880
 - 82598490 Walnut \$3880 → \$3280
 - L150 x D65 x H60cm
 - a 38727811 Oak \$4880 → \$4280
 - 02422547 Walnut \$5280 → \$4580
 - L150 x D80 x H60cm



65cm

80cm



木製兩用檯 小
Wooden Living Dining Table S

- 新價格**
- 82598421 Oak \$3080 → \$2580
 - 82598506 Walnut \$3580 → \$2880
 - L130 x D65 x H60cm
 - b 38727828 Oak \$4480 → \$3880
 - 82598520 Walnut \$4880 → \$4280
 - L130 x D80 x H60cm

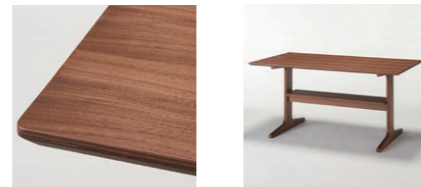

木製兩用座椅
Wooden Living Dining Chair

- a 82598469 Oak **新價格** \$2280
- b 82598537 Walnut **新價格** \$2600 → \$2580
- L55 x D78 x H77cm
- 座面：H41cm



木製兩用座椅扶手
Armrest for Wooden Living Dining Chair

- c 82602784 Oak **新價格** \$250 → \$228
- 02431150 Walnut **新價格** \$258
- 2pcs L4.5 x D45.5 x H28.5cm



木製兩用座椅連接配件
Connecting Plate for Living Dining Chair

- 82598452 2pcs **新價格** \$80 → \$78



木製兩用兩座位長檯
Wooden Living Dining 2 Seats Bench

- d 82598476 Oak **新價格** \$1880
- 82598544 Walnut **新價格** \$2400 → \$2280
- L113 x D46 x H40.5cm



木製兩用單座位長檯
Wooden Living Dining 1 Seat Bench

- 82598483 Oak **新價格** \$1280
- e 82598551 Walnut **新價格** \$1600 → \$1580
- L56 x D46 x H40.5cm

物料 Material	座椅套/長檯套 Chair/ Bench Cover	兩座位長檯 2 Seats Bench	單座位長檯 1 Seat Bench	兩用座椅 Living Dining Chair
棉質 Cotton	 Beige Brown Dark Brown	\$420 82008999 Beige 82007862 Brown 82007893 Dark Brown	\$300 82009002 Beige 82007879 Brown 82007909 Dark Brown	\$480 82008982 Beige 82007855 Brown 82007886 Dark Brown
棉麻 Cotton Linen	 Raw White Beige Charcoal	\$380 82585186 Raw White 82585483 Beige 82585780 Charcoal	\$250 82585193 Raw White 82585490 Beige 82585797 Charcoal	\$450 82585179 Raw White 82585476 Beige 82585773 Charcoal
綿帆布 Cotton Canvas	 Raw White Light Gray Melange Beige	\$420 82583601 Raw White 44617090 Light Gray 44617076 Melange Beige	\$300 82583618 Raw White 44617137 Light Gray 44617106 Melange Beige	\$480 82583595 Raw White 44617069 Light Gray 44617045 Melange Beige
棉質牛仔布 Cotton Denim	 Blue Navy	\$380 02101718 Blue 02101732 Navy	\$250 02101725 Blue 02101749 Navy	\$450 38740063 Blue 38740070 Navy



PUUF 豆袋梳化 PUUF Beads Sofa

PUUF豆袋梳化圓形的形狀，猶如動物或棉花糖般具親切感。無論是閱讀、觀看電視或放鬆休息時，內裡的微小顆粒會因應身體重量及細微的姿勢而調節，貼服地承托身體。



PUUF 豆袋梳化
PUUF Beads Sofa

15915705 Gray
Dia 70 x H35cm

15915712 Navy

\$1680



Ash Gray



Gray



White x Black Mix



Mustard



Asian Blue



Blue Gray



Sepia Brown



Sage Green



Navy



Black x Gray Mix

MINI PUUF 豆袋梳化
MINI PUUF Beads Sofa

82885927 Ash Gray
38740728 Blue Gray
Dia 42 x H22cm

15915668 Gray
82885903 Sepia Brown

38740742 White x Black Mix
82885910 Sage Green

38740735 Mustard
15915712 Navy

82885897 Asian Blue
38740759 Black x Gray Mix
\$1100

IDÉE 梳化 IDÉE Sofa

從簡潔的客廳到精緻的現代客廳，你可根據個人生活方式和坐感，選擇合適的梳化款式。



AO 梳化
AO Sofa
[44592700] Gray \$3800
[44592694] Charcoal
L140 x D71 x H59cm



MINI MILLER 扶手椅
MINI MILLER Arm Chair
[02509002] \$4800
L60 x D67 x H55cm



DIMANCHE 真皮梳化
DIMANCHE Leather Sofa
[37732650] Marron \$32800
L207 x D90 x H80cm



DIMANCHE 布藝梳化
DIMANCHE Sofa
[02509019] Charcoal \$25800
L190 x D90 x H80cm

IDÉE 桌子及家具 IDÉE Table and Interior Accessories

簡潔的高蹠桌子可作為辦公桌及學習桌使用，用途廣泛。
將經常穿着及使用的衣服、手提袋及隨身配飾放置於衣架上，方便存取。



Stilt 高蹠桌子
Stilt Table
a [44592717] White \$6800
[44592762] Natural
L120 x D80 x H72.5cm
[10 ii]



Stilt 高蹠桌子
Stilt Table
b [44592755] White \$5200
[44592748] Natural
L100 x D60 x H72.5cm
[10 ii]



SOUDIEUX 桌子
SOUDIEUX Table
[37597440] Natural \$13800
L140 x D80 x H71.5cm
[20 ii]



橡木茶几
White Oak Frame Table
[38360643] Natural \$8500
L120 x D55 x H36cm
[20 ii]



DIMANCHE 茶几
DIMANCHE Low Table
[37732711] Natural \$6800
L120 x D55 x H38cm

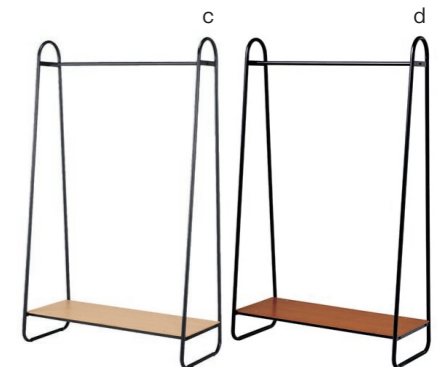

衣架
Paul Hanger Stand
c [44592786] Natural \$1500
d [44592779] Anton Brown
L90 x D40.5 x H150cm
[15 i]

橡膠木書檯 Rubberwood Desk

簡潔實用的橡膠木書檯，能滿足不同工作及學習需要。配合各種素材和款式的文件櫃及工作椅，讓家居成為舒適工作間。



活動升降椅
Working Chair

c [18121298] Light Gray \$1250
d [18121304] Black
L55.5 x D53 x H74-84cm
🔧 20 ii

升降椅用扶手
Armrest for Working Chair

[18121861] Light Gray 2pcs \$250
[18121878] Black 2pcs
🔧 10 i



PP可堆疊椅
PP Stackable Stool

e [02850692] Light Gray \$220
f [44859957] Dark Gray
L43 x D34 x H45cm
座面：H42cm
◎5

橡膠木書檯組合
Rubberwood Desk Set

a [31116070] Light Brown \$2280
書檯: L110 x D55 x H70cm
層架: L109 x D20 x H30cm
🔧 15 ii

橡膠木櫃
Rubberwood Desk Cabinet

b [12828815] Light Brown \$1680
L39 x D48 x H58cm



鋼質文件櫃
Steel Cabinet

[44215227] Light Gray \$1980
L39.5 x D56 x H59.5cm



小件家具·茶几 Home Accessories · Low Table

小件家具設計實用簡潔，照顧基本用途所需，自然融入生活空間。

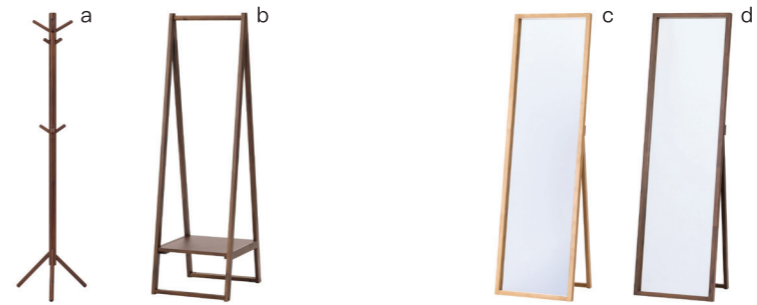

槐木衣帽架
Acacia Coat Stand

a [83001100] Dark Brown \$480
L48 x D42 x H173.5cm
🔧 10 i

槐木掛衣帽架
Acacia Coat Rack

b [83001117] Dark Brown \$780
L44 x D53 x H150.5cm
🔧 20 i

橡膠木鏡
Rubberwood Mirror

c [44148792] Light Brown \$980
L44 x D38.5 x H150cm
🔧 15 ii

槐木鏡
Acacia Mirror

d [83001490] Dark Brown \$980
L44 x D38.5 x H150cm
🔧 15 ii

鋁質座檯鏡
Aluminium Compact Mirror

e [15574940] \$250
L20.5 x D18 x H40-51cm
f [15574957] \$180
L17 x D14 x H27cm



鋅鐵園藝架
Molten Zinc Gardening Shelf

g [38994602] \$980
L84 x D30 x H85cm
▲全架約35kg

可摺式鋅鐵園藝架
Molten Zinc Foldable Gardening Shelf

h [38994596] \$680
L84 x D30 x H62cm
▲全架約25kg

可摺式鋅鐵園藝架
Molten Zinc Foldable Gardening Shelf

[38994589] \$980
L56 x D33 x H99cm
▲上段約3kg、中段約4kg、下段約5kg



橡膠木橢圓茶几
Rubberwood Low Table Oval

[12828433] Light Brown \$1580
L140 x D79 x H35cm
🔧 10 ii

j [12828457] Light Brown \$1180
L110 x D62 x H35cm
🔧 10 ii

橡膠木椅
Rubberwood Bench

k [12841036] Small \$580
L48.5 x D30 x H44cm
座面：L43 x D14cm
l [12841043] Large \$780
L100 x D30 x H44cm
座面：L100 x D14cm



橡木床 Oak Wood Bed

以色彩柔和的橡木素材製成，線條簡潔，能自然融入生活空間。採用卡榫式設計，不需借助額外工具即可組裝固定，輕鬆簡單。



• 以上床架均不包括床褥。 Mattress is not included in all bed items.



橡木床
Oak Wood Bed

82944495	Single	\$2280
L100.5 x D201.5 x H74cm		
82944501	Semi Double	\$2580
L123 x D201.5 x H74cm		
82944518	Double	\$3280
L143 x D201.5 x H74cm		
82944525	Queen	\$3580
L163 x D201.5 x H74cm		
床面 H31cm / 床下 H20cm		
床架：橡木積層合板 (Oak Wood Laminated Veneer Lumber)、 橡木薄板 (Oak Wood Veneer)		
床腳：橡木 (Oak Wood Solid Board)、聚氨酯樹脂塗層 (Polyurethane)		

15 ii

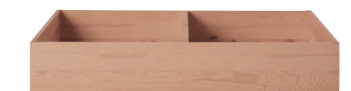

橡木床地櫃
Oak Wood Bed Storage Box

44303986	\$880
L94.5 x D62.5 x H18.5cm	
內寸: L90.8 x D59.5 x H13.6cm	

20 ii



床底櫃用棉麻纖維蓋
Polyester Cotton Linen Underbed Storage Cover

44831458	\$120
L95 x D63cm	



聚酯棉麻儲物箱
Polyester Cotton Linen Storage Box

18492718	\$350
L39 x D59cm x H18cm	

木製床架 Wooden Bed Frame

為增加舒適度，新設富有彈性的床條板，薄身設計，簡約且沒有壓迫感。
可選擇橡木或胡桃木材質。組裝設計方便搬運。



自由組合

於床架上加上床頭板、床褥及不同高度的床腳，配合床下收納配件，成為滿足個人喜好及用途需要的床架收納組合。

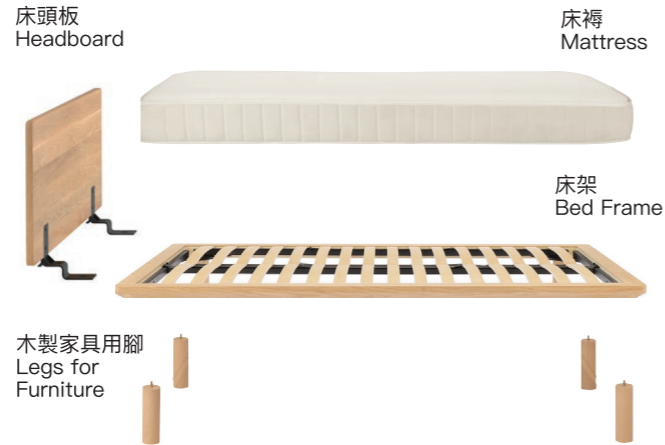

組合例子



橡木單人床架 \$2880
木製家具用腳H26cm \$250
木製床架用儲物地櫃H25cm x 2 \$2300
組合價 \$5430

以上床架均不包括床褥。
Mattress is not included in all bed items.



橡木單人床架 \$2880
木製家具用腳H20cm \$200
組合價 \$3080



胡桃木單人床頭板 \$1080
胡桃木單人床架 \$3280
木製家具用腳H26cm \$250
木製床架用儲物地櫃H25cm x 2 \$2500
組合價 \$7110

以上床架均不包括床褥。
Mattress is not included in all bed items.



胡桃木單人床架 \$3280
木製家具用腳H20cm \$200
木製床架用儲物地櫃H19cm x 2 \$2300
組合價 \$5780



木製單人床架
Wooden Bed Frame Single
83222031 Oak \$2880
83222093 Walnut \$3280
L103 x D202 x H5.5cm



木製單人加大床架
Wooden Bed Frame Semi Double
83222048 Oak \$3280
83222109 Walnut \$3580
L123 x D202 x H5.5cm



木製雙人床架
Wooden Bed Frame Double
83222055 Oak \$3880
83222116 Walnut \$4280
L147 x D202 x H5.5cm



木製雙人加大床架
Wooden Bed Frame Queen
83222062 Oak \$4280
83222123 Walnut \$4580
L171 x D202 x H5.5cm
• 只可配搭 20cm / 26cm 家具用腳



家具用腳 Legs for Furniture	a	b	c
尺寸 Size	Dia6 x H12cm	Dia6 x H20cm	Dia6 x H26cm
物料 Material	Wooden Natural a 02529406	Wooden Natural 02528355	Wooden Natural 02529444
	\$200	\$200	\$250
	02529413	b 02529437	c 02528041



橡木單人加大床架 x 2 不使用家具用腳
*如不使用家具用腳，則無法安裝床頭板。



橡木單人床架 + H25cm家具用腳



木製單人床頭板
Headboard for Wooden Bed Frame Single
82579598 Oak \$980
82579659 Walnut \$1080
L103 x D2.5 x H45cm



木製單人加大床頭板
Headboard for Wooden Bed Frame Semi Double
82579604 Oak \$1080
82579666 Walnut \$1180
L123 x D2.5 x H45cm



木製雙人床頭板
Headboard for Wooden Bed Frame Double
82579611 Oak \$1280
82579673 Walnut \$1380
L147 x D2.5 x H45cm



木製雙人加大床頭板
Headboard for Wooden Bed Frame Queen
82579628 Oak \$1380
82579680 Walnut \$1480
L171 x D2.5 x H45cm

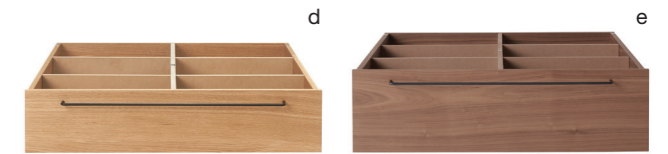

木製床架儲物地櫃
Wooden Underbed Storage Drawer

d 02554019 Oak \$1050
02554026 Walnut \$1150
L80 x D90.5 x H19cm
內寸：L76.5 x D83.5 x H13.5cm

e 02550929 Oak \$1150
02550936 Walnut \$1250
L80 x D90.5 x H25cm
內寸：L76.5 x D83.5 x H19.5cm



橡木雙人床架 + H20cm家具用腳



橡木雙人床架 + H20cm家具用腳

床褥 Mattress

床褥採用不同素材及構造設計製成，軟硬度及睡感各異，照顧你的睡眠需要。

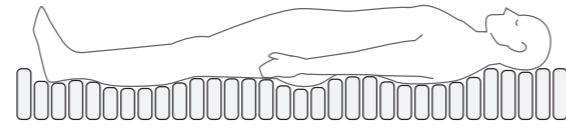
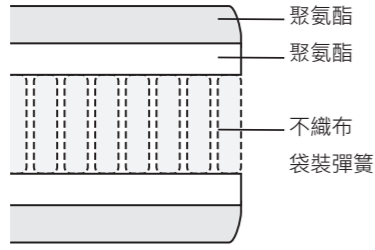

- 獨立的袋裝彈簧緊貼身體曲線，令睡眠時保持穩定的姿勢。
- 床褥套可拆除清洗，方便日常保養。

高密度袋裝彈簧床褥 High Density Pocket Coil Mattress

[44502938] Single L97 x D195 x H19cm	\$3280	[44502945] Semi Double L120 x D195 x H19cm	\$4280	[44502952] Double L140 x D195 x H19cm	\$4580	[44502969] Queen L160 x D195 x H19cm	\$6280
---	--------	---	--------	--	--------	---	--------

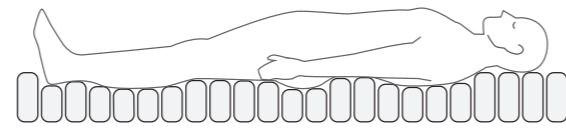
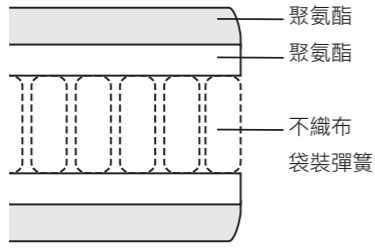

- 獨立袋裝彈簧的排列經細心考量，以多個「點」平均支撐身體重量，有助避免床褥搖晃，帶來安定睡感。
- 床褥套可拆除清洗，方便日常保養。

袋裝彈簧床褥 Pocket Coil Mattress

[44502990] Single L97 x D195 x H19cm	\$2800	[44503003] Semi Double L120 x D195 x H19cm	\$3500	[44503010] Double L140 x D195 x H19cm	\$3800	[44503027] Queen L160 x D195 x H19cm	\$4800
---	--------	---	--------	--	--------	---	--------



聚酯纖維軟床面墊 Polyester Foam Mattress Topper Medium Type

[82944440] Single L97 x D190 x H5.5cm	\$780	[82944457] Semi Double L120 x D190 x H5.5cm	\$880	[82944464] Double L140 x D190 x H5.5cm	\$980	[82944471] Queen L160 x D190 x H5.5cm	\$1280
--	-------	--	-------	---	-------	--	--------

聚酯纖維床面墊 Polyester Foam Mattress Topper Hard Type

[82944389] Single L97 x D190 x H5.5cm	\$780	[82944396] Semi Double L120 x D190 x H5.5cm	\$880	[82944402] Double L140 x D190 x H5.5cm	\$980	[82944419] Queen L160 x D190 x H5.5cm	\$1180
--	-------	--	-------	---	-------	--	--------

保養建議

定期將床褥豎立，讓內裡的空氣得以流通，有助避免濕氣積聚。另外，每季把床褥頭尾對調及上下翻轉，可避免受力點只集中一方，令床褥的承托力更平均。

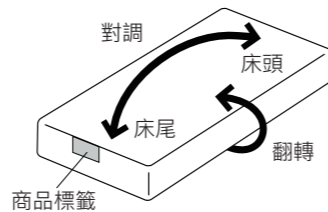

PP儲物 PP Storage

採用半透明的PP素材製成，從外能隱約識別內藏物件，方便取用。備有抽屜、揭蓋、儲物架及組立式層架等多種款式選擇，可自由組合或加裝活輪使用，應付不同用途需要。

可用於床底、衣櫃等較大的收納空間，整理衣物或其他大型物件。

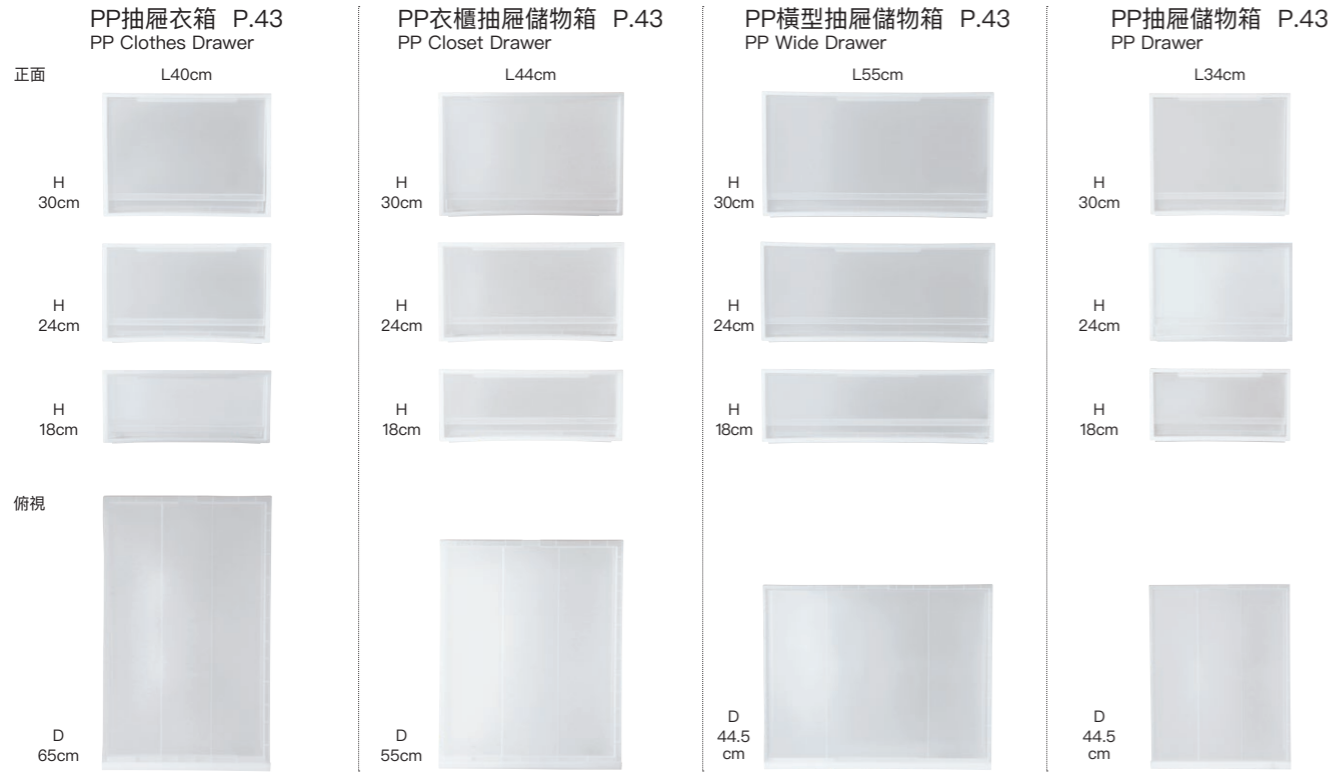

外寸約相等於A4尺寸，可用作收納文件、文具及其他零散小物。

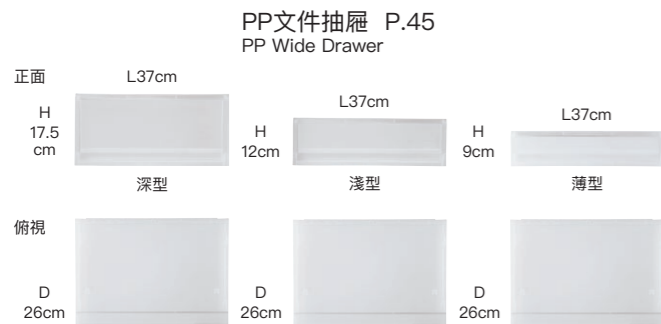
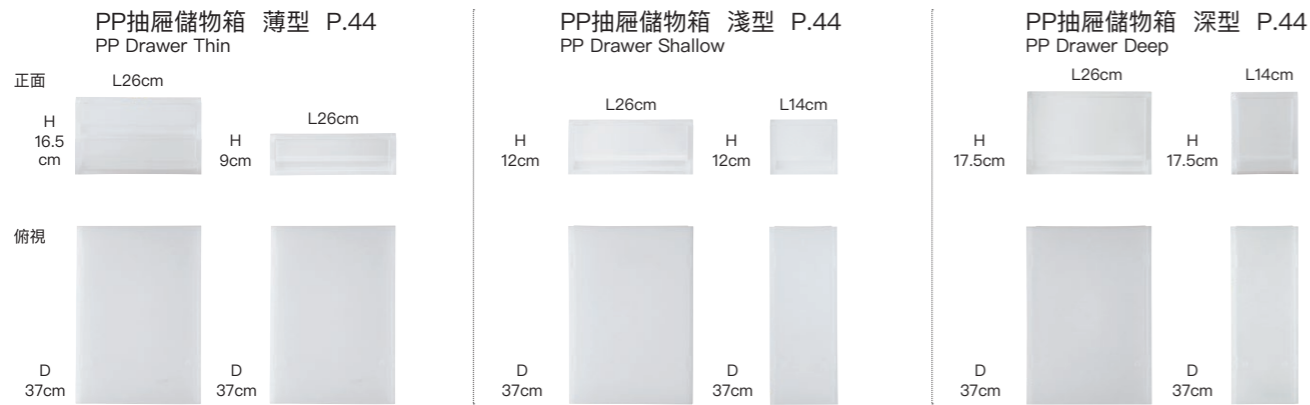

尺寸指示	日本語	中文	English
	L	幅	Length
	D	奥行	Depth
	H	高	Height

揭蓋及可摺合款式，便於搬運。

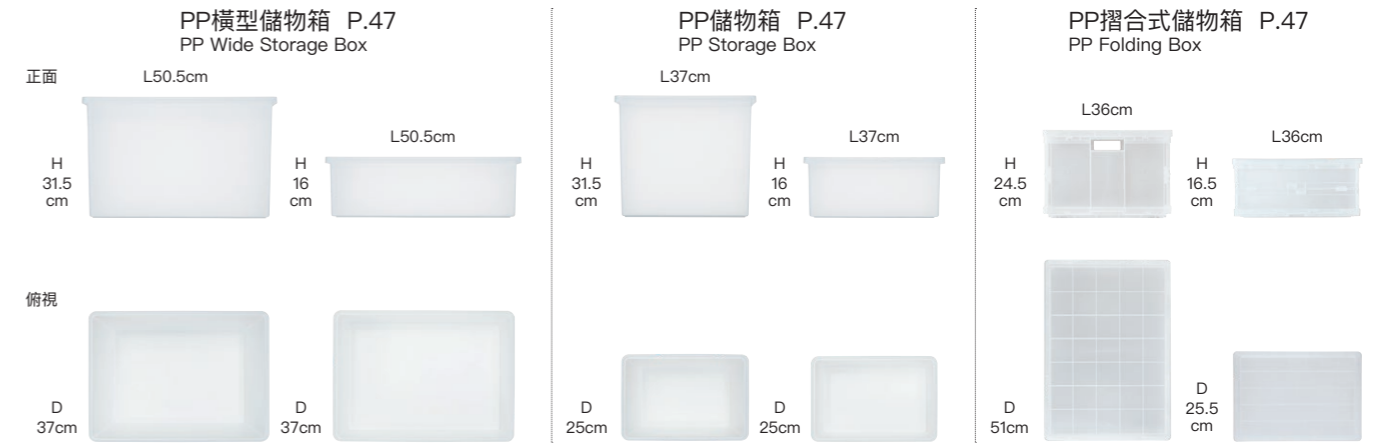

開放型組立式層架，方便取用所需物件。

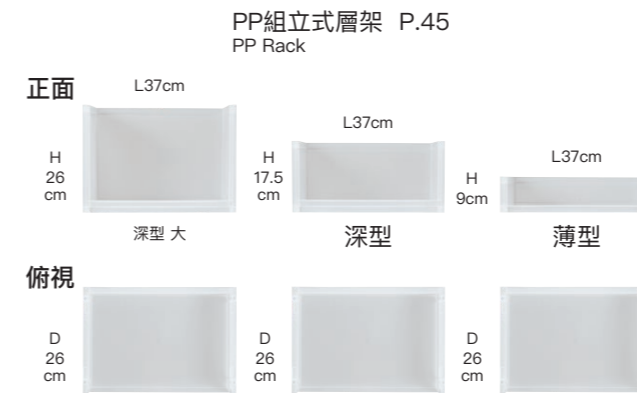

有助善用玄關、廚房及浴室等較狹窄的空間。

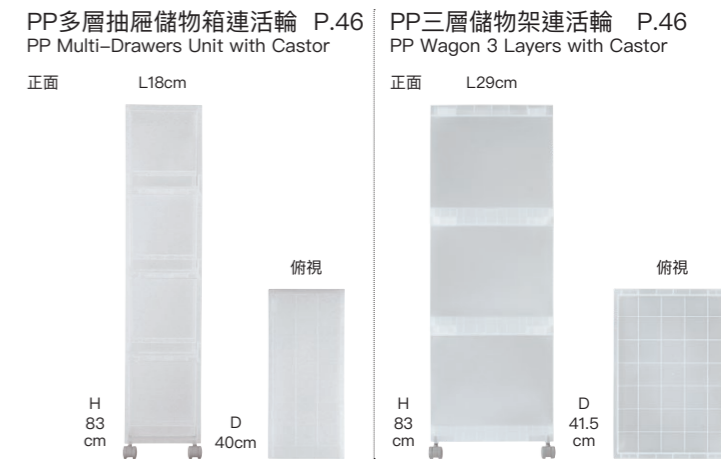

堅固耐用，可用於戶外或當作椅子使用。





不織布纖維四格儲物盒
Non-Woven Fabric Separation Case
with 4 Compartments

- a [02502881] 2pcs \$68
L11 x D32.5 x H11cm
- [02502874] 2pcs \$78
L15 x D32.5 x H11cm
- [02502867] 2pcs \$88
L22.5 x D32.5 x H11cm

不織布纖維十二格儲物盒
Non-Woven Fabric Separation Case
with 12 Compartments

- b [02502898] \$78
L22.5 x D32.5 x H11cm

不織布纖維可調節高度儲物盒
Non-Woven Fabric Height Adjustable
Separation Case

- [02110468] 2pcs \$68
L11 x D32.5 x H21cm
- c [02110475] 2pcs \$78
L15 x D32.5 x H21cm
- [02110482] 2pcs \$88
L22.5 x D32.5 x H21cm

PP抽屜儲物箱
PP Drawer

- g [18816170] Small \$128
L34 x D44.5 x H18cm
▲5kg ◎9
- h [18816163] Large \$168
L34 x D44.5 x H24cm
▲5kg ◎7
- i [18816156] Deep \$188
L34 x D44.5 x H30cm
▲5kg ◎6

PP衣櫃抽屜儲物箱
PP Closet Drawer

- m [15236640] Small \$148
L44 x D55 x H18cm
▲7kg ◎8
- n [15199709] Large \$168
L44 x D55 x H24cm
▲7kg ◎7
- o [15199693] Deep \$208
L44 x D55 x H30cm
▲7kg ◎6



PP抽屜儲物箱 薄型
PP Drawer Thin

- a [76749066] \$78
- b [02108281] White Gray
L26 x D37 x H9cm
▲2kg ◎13
[A4] [X]



PP兩層抽屜儲物箱 薄型
PP Drawer 2 Layers Thin

- c [76749073] \$128
L26 x D37 x H16.5cm
▲2kg ◎7
[A4] [X]



PP六格抽屜儲物箱 淺型
PP Drawer 6 Units Shallow

- d [76749004] \$328
L26 x D37 x H32.5cm
▲1.5kg ◎3
[X]



PP三層抽屜儲物箱 淺型
PP Drawer 3 Layers Shallow

- e [37192430] \$228
L26 x D37 x H32.5cm
▲3kg ◎3
[A4] [X]



PP抽屜儲物箱 淺型
PP Drawer Shallow

- f [37192423] \$98
- g [15253579] White Gray
L26 x D37 x H12cm
▲3kg ◎10
[A4] [X]

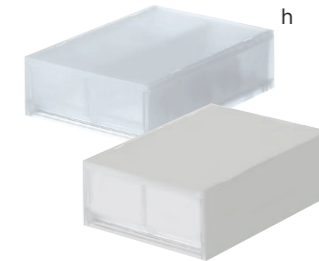

PP兩格抽屜儲物箱 淺型
PP Drawer 2 Units Shallow

- h [76748984] \$148
- i [02108304] White Gray
L26 x D37 x H12cm
▲1.5kg ◎10
[X]

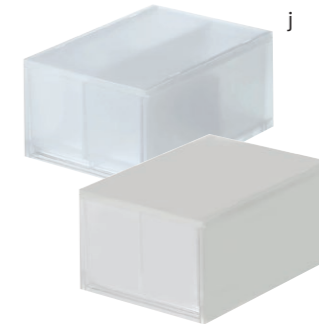

PP兩格抽屜儲物箱 深型
PP Drawer 2 Units Deep

- j [76749028] \$168
- k [02108274] White Gray
L26 x D37 x H17.5cm
▲2kg ◎6
[X]



PP抽屜儲物箱 深型
PP Drawer Deep

- l [37192447] \$128
- m [15253586] White Gray
L26 x D37 x H17.5cm
▲4kg ◎6
[A4] [X]



PP半型抽屜儲物箱
PP Half Drawer

- n [76749042] Shallow \$78
L14 x D37 x H12cm
▲1.5kg ◎6
- o [76749035] Deep \$98
L14 x D37 x H17.5cm
▲2kg ◎4
[X]



PP橫型抽屜儲物箱
PP Wide Drawer

- d [76331490] Small \$208
L55 x D44.5 x H18cm
▲3kg ◎5
- e [76331483] Large \$228
L55 x D44.5 x H24cm
▲3kg ◎5
- f [76331476] Deep \$268
L55 x D44.5 x H30cm
▲2.5kg ◎4

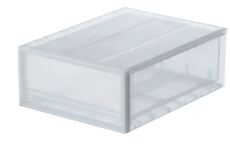

PP抽屜衣箱
PP Clothes Drawer

- j [15112104] Small \$148
L40 x D65 x H18cm
▲7kg ◎8
- k [15112098] Large \$168
L40 x D65 x H24cm
▲7kg ◎7
- l [15112081] Deep \$208
L40 x D65 x H30cm
▲7kg ◎6

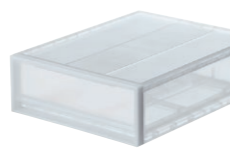



PP文件抽屜 薄型
PP Wide Drawer Thin

15253753 \$98
02108335 White Gray
L37 x D26 x H9cm
▲1kg ◎13

A4



PP文件抽屜 淺型
PP Wide Drawer Shallow

15253784 \$98
02108328 White Gray
L37 x D26 x H12cm
▲1.5kg ◎10

A4



PP兩格文件抽屜 薄型
PP Wide 2 Drawer Thin

15253777 \$128
02118990 White Gray
L37 x D26 x H9cm
▲0.5kg ◎13

A4



PP文件抽屜 深型
PP Wide Drawer Deep

15253791 \$128
02108311 White Gray
L37 x D26 x H17.5cm
▲2kg ◎6

A4



PP組立式層架 深型 大
PP Rack Deep Large

82243963 \$98
L37 x D26 x H26cm
▲5kg ◎4

A4



PP組立式層架 深型
PP Rack Deep

82243956 \$78
L37 x D26 x H17.5cm
▲4kg ◎6

A4



PP組立式層架 薄型
PP Rack Thin

82243949 \$68
L37 x D26 x H9cm
▲3kg ◎13

A4

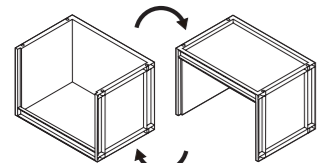

可倒轉方向使用

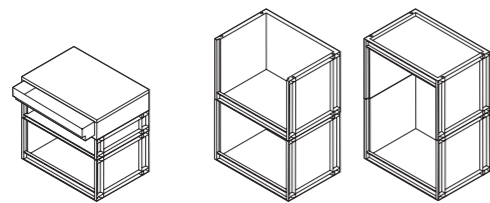

可與抽屜儲物箱層疊使用

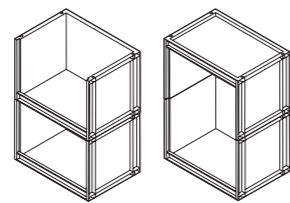

可倒轉方向層疊使用

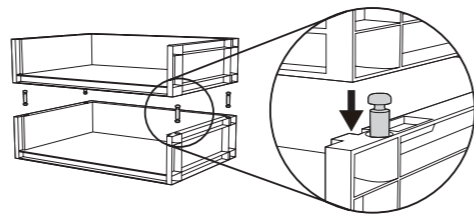

可於四角加裝活輪，或加設防滑塞子以層疊使用。

- 層疊使用之高度上限為120cm
- 整體負重量上限：不使用活輪時約39kg
使用活輪並以相反方向組裝時約19.5kg



PP儲物用活輪
Castor for PP Storage

15523788 4pcs \$38

- 使用後，因應不同種類之PP儲物箱，高度會升高3.8 - 4.2cm。



PP儲物用防滑塞子
Stopper for PP Storage

47554908 Small 4pcs \$25
47554892 Large 4pcs



PP儲物盒用連接配件
Connecting Parts for PP Storage

02528508 2pcs \$18

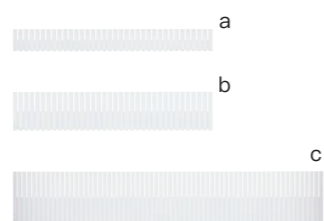

PP儲物用整理隔板
PP Partition for PP Storage

a 38369608 Small 5pcs \$48
L36 x D0.2 x H4cm

b 38369615 Medium 5pcs \$58
L36 x D0.2 x H7cm

c 38369622 Large 4pcs \$78
L65.5 x D0.2 x H11cm



PP三層抽屜儲物箱連活輪
PP3 Drawers Unit with Castor

15880188 \$328
L18 x D40 x H83cm
可於頂層加裝儲物箱
建議如下：
抽屜式淺型(15880171)：+3個；或
抽屜式(47721584)：+2個；或
抽屜式深型(15880164)：+1個
• 高度上限：122cm
▲30kg

A4



PP四層抽屜儲物箱連活輪
PP4 Drawers Unit with Castor 1

15880195 \$328
L18 x D40 x H83cm
可於頂層加裝儲物箱
建議如下：
抽屜式淺型(15880171)：+3個；或
抽屜式(47721584)：+2個；或
抽屜式深型(15880164)：+1個
• 高度上限：122cm
▲30kg

A4



PP四層抽屜儲物箱連活輪
PP 4 Drawers Unit with Castor 2

15521821 \$288
L18 x D40 x H83cm
可於頂層加裝儲物箱
建議如下：
抽屜式淺型(15880171)：+3個；或
抽屜式(47721584)：+2個；或
抽屜式深型(15880164)：+1個
• 高度上限：122cm
▲30kg



PP單層抽屜儲物箱 深型
PP Single Drawer Deep

15880164 \$128
L18 x D40 x H30.5cm
▲5kg ◎4

A4



PP單層抽屜儲物箱
PP Single Drawer

47721584 \$88
L18 x D40 x H21cm
▲5kg ◎5



PP單層抽屜儲物箱 薄型
PP Single Drawer Thin

15880171 \$68
L18 x D40 x H11cm
▲2.5kg ◎10



PP三層儲物架連活輪
PP Wagon 3 Layers with Castor

15253807 \$228
L29 x D41.5 x H83cm
▲8kg



PP密封儲物箱
PP Sturdy Storage Box

44620847 XL 70L \$288
L78 x D39 x H37cm
▲100kg ◎2



44620830 L 50L \$208
L60 x D39 x H37cm
▲100kg ◎3



44620823 S 30L \$148
L40 x D39 x H37cm
▲100kg ◎3



44620816 Mini 22L \$128
L39.5 x D29.5 x H37cm
▲100kg ◎2

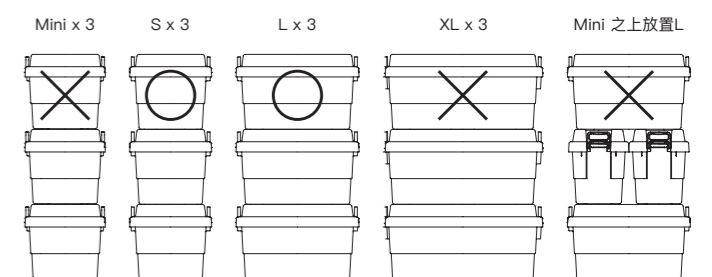



PP摺合式儲物箱 大
PP Folding Box L

47686715 \$168
L36 x D51 x H24.5cm
7kg
10
A4



PP摺合式儲物箱 小
PP Folding Box S

47686708 \$98
L25.5 x D36 x H16.5cm
5kg
8
A4



PP板車
PP Wheeled Platform

82007848 \$188
L27.5 x D41 x H7.5cm
80kg



PP儲物箱 深
PP Storage Box Deep

82219401 \$98
L37 x D25 x H31.5cm
8kg
4
A4



PP儲物箱 中
PP Storage Box M

82219418 \$68
L37 x D25 x H16cm
5kg
8
A4



PP儲物箱內托盤
PP Storage Box Inner Tray

82219449 \$38
L35 x D23 x H5.5cm
1.5kg



PP儲物箱專用蓋
PP Storage Box Lid

82219432 \$25
L37.5 x D25.5 x H2.5cm
35kg



PP橫型儲物箱 深
PP Wide Storage Box Deep

82219326 \$108
L50.5 x D37 x H31.5cm
12kg
4
A4



PP橫型儲物箱 大
PP Wide Storage Box L

82219333 \$98
L50.5 x D37 x H16cm
8kg
8
A4



PP橫型儲物箱專用蓋
PP Wide Storage Box Lid

82219357 \$48
L51 x D37.5 x H2.5cm
35kg



PE儲物 Soft PE Storage

採用質感柔韌的PE素材製成，具有良好的防水及耐冷性，用途廣泛且易於清潔。
配以專用蓋便可層疊擺放，節省收納空間。



PE儲物盒
Soft PE Case

15197804 Deep \$95
L25.5 x D36 x H32cm
A4



15197859 Large \$88
L25.5 x D36 x H24cm
A4



15197842 Medium \$62
L25.5 x D36 x H16cm
A4



15197835 Small \$48
L25.5 x D36 x H8cm
A4



PE儲物盒 半型
Soft PE Case Half

15197798 Large \$62
L18 x D25.5 x H24cm
A4



15197781 Medium \$58
L18 x D25.5 x H16cm
A4



15197774 Small \$40
L18 x D25.5 x H8cm
A4

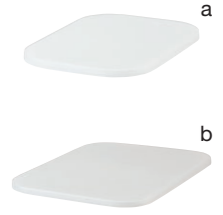

PE儲物盒用蓋
Lid for Soft PE Case

a 15197828 Half \$18
L18.5 x D26 x H1.5cm
b 15197811 \$30
L26 x D36.5 x H1.5cm



PE儲物盒 圓形
Soft PE Case Round

02528591 Deep \$95
Dia36 x H32cm



02528584 Medium \$70
Dia36 x H16cm



PE儲物盒圓形蓋
Lid for Soft PE Case Round

02528492 \$25
Dia36 x H1.5cm



椰織編織儲物 Buri Storage

選用菲律賓產的椰織素材，並以人手逐一編織而成，呈現天然素材的樸實質感。配以專用蓋便可層疊擺放；另備附手挽的款式，方便提取。



椰織編織可疊式長方形儲物籃
Buri Stackable Rectangle Basket

[18014002] L \$180
L37 x D26 x H24cm
A4



[47027914] M \$120
L37 x D26 x H16cm
A4



a [47027907] S \$90
L37 x D26 x H12cm
A4

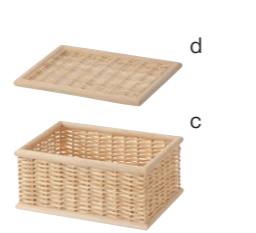

椰織編織可疊式長方形儲物籃
Buri Stackable Rectangle Basket

c [47027921] \$70
L26 x D18.5 x H12cm
A4

椰織編織長方形儲物籃用蓋
Buri Rectangle Basket Lid

b [18014026] \$40
L37 x D26 x H2cm

椰織編織長方形儲物籃用蓋
Buri Rectangle Basket Lid

d [18014033] \$30
L26 x D18.5 x H2cm



椰織編織可疊式方形儲物籃
加大
Buri Stackable Square Basket XL

[47027945] \$220
L35 x D37 x H32cm
A4



椰織編織可疊式方形儲物籃
大
Buri Stackable Square Basket L

[18013999] \$200
L35 x D37 x H24cm
A4



椰織編織可疊式方形儲物籃
中
Buri Stackable Square Basket M

[47027938] \$150
L35 x D37 x H16cm
A4



椰織編織方形儲物籃用蓋
Buri Square Basket Lid

[18014019] \$50
L35 x D37 x H2cm



藤織儲物 Rattan Storage

以人手將藤枝逐一編織而成，輕巧堅韌，質感光滑。配以專用蓋便可層疊擺放；另備附手挽的款式，方便提取。



藤織可疊式長方形儲物籃
Rattan Stackable Rectangle Basket

[38309819] XL \$280
L36 x D26 x H31cm
A4



[47381313] L \$250
L36 x D26 x H24cm
A4



[47381306] M \$180
L36 x D26 x H16cm
A4

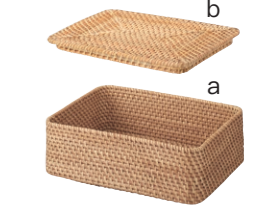

a [47381290] S \$180
L36 x D26 x H12cm
A4

藤織長方形儲物籃用蓋
Rattan Stackable Basket Lid

b [15004768] \$70
L36 x D26 x H3cm



藤織可疊式長方形儲物籃連蓋
Rattan Stackable Rectangle Basket with Lid

[47381337] \$180
L26 x D18 x H16cm
A4



藤織可疊式長方形儲物籃
Rattan Stackable Rectangle Basket

[47381238] \$160
L26 x D18 x H12cm
A4



藤織小物盛器
Rattan Rectangle Basket

[37525702] \$70
L26 x D9 x H6cm
A4



藤織方形儲物籃連手挽 大
Rattan Square Basket with Handle L

[18021826] \$280
L35 x D36 x H24cm
A4



藤織方形儲物籃連手挽 中
Rattan Square Basket with Handle M

[18021833] \$250
L35 x D36 x H16cm
A4



藤織方形儲物籃用蓋
Rattan Square Basket Lid

[15004775] \$90
L35 x D36 x H3cm



藤織小物盛器連手挽
Rattan Box with Handle

[47028454] \$100
L15 x D22 x H9cm

藤織籃的產地

無印良品的藤織籃生產於越南北部農村地區。除農耕及畜牧外，該地亦是著名的藤織品、竹製品等手工藝品產地。



編織過程

當地農家會將直徑3至5cm的藤條分成直徑5至8mm的藤枝，再以人手逐一編織成籃。每人每天能製作最多1至2個藤籃，過程相當耗時。

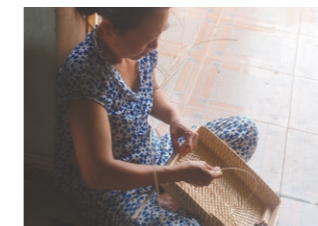

可配合不織布纖維儲物盒使用

聚酯棉麻儲物 Cotton Linen Polyester Storage

布料內側經塗層加工，耐用度高且易於清潔。採用統一尺寸，可配合層架使用。不使用時可摺疊收藏，節省收納空間。



聚酯棉麻長形儲物籃 大
Cotton Linen Polyester Soft Box
Rectangle L

12403449 \$85

L37 x D26 x H34cm



聚酯棉麻長形儲物籃連蓋 中
Cotton Linen Polyester Soft Box
Rectangle with Lid M

12428909 \$85

L37 x D26 x H26cm



聚酯棉麻長形儲物籃 中
Cotton Linen Polyester Soft Box
Rectangle M

12403487 \$75

L37 x D26 x H26cm



聚酯棉麻長形儲物籃 小
Cotton Linen Polyester Soft Box
Rectangle S

12403432 \$58

L37 x D26 x H16cm



聚酯棉麻方形儲物籃連蓋 大
Cotton Linen Polyester Soft Box
Square with Lid L

12403494 \$98

L35 x D35 x H32cm



聚酯棉麻方形儲物籃 大
Cotton Linen Polyester Soft Box
Square L

12403456 \$98

L35 x D35 x H32cm



聚酯棉麻方形儲物籃連蓋 小
Cotton Linen Polyester Soft Box
Square with Lid S

12403463 \$85

L35 x D35 x H16cm



聚酯棉麻方形儲物籃 小
Cotton Linen Polyester Soft Box
Square S

12403470 \$75

L35 x D35 x H16cm



聚酯棉麻衣物用儲物籃連蓋 大
Cotton Linen Polyester Soft Box
Cloth Case L

12403531 \$138

L59 x D39 x H23cm



聚酯棉麻衣物用儲物籃連蓋 中
Cotton Linen Polyester Soft Box
Cloth Case M

12403524 \$128

L59 x D39 x H18cm



聚酯棉麻半型儲物籃連蓋 中
Cotton Linen Polyester Soft Box
Half with Lid M

12403500 \$75

L18.5 x D26 x H26cm



聚酯棉麻半型儲物籃 中
Cotton Linen Polyester Soft Box
Half M

12428893 \$58

L18.5 x D26 x H26cm



聚酯棉麻半型儲物籃 小
Cotton Linen Polyester Soft Box
Half S

12403517 \$48

L18.5 x D26 x H16cm



聚酯棉麻半型儲物籃
Cotton Linen Polyester Soft Box
Half

12403548 \$45

L13 x D37 x H12cm



硬質紙儲物 Hard Pulp Storage

採用再造紙製成，並以金屬配件加固，輕巧堅固。



硬質紙單層抽屜
Hard Pulp 1 Drawer

15967162 \$150

L25.5 x D36 x H16cm

內寸：L23 x D34 x H14cm

▲2kg ◎3



硬質紙兩層抽屜
Hard Pulp 2 Drawers

15967179 \$220

L25.5 x D36 x H16cm

內寸：L23 x D34 x H6.5cm

▲1.5kg ◎3



硬質紙兩層抽屜 橫型
Hard Pulp 2 Drawers Wide

15967087 \$280

L36 x D25.5 x H16cm

內寸：L34 x D24 x H6.5cm

▲1.5kg ◎2



硬質紙四格抽屜 橫型
Hard Pulp 4 Drawers Wide

15967223 \$320

L36 x D25.5 x H16cm

內寸：L16 x D24 x H6.5cm

▲2kg ◎2



硬質紙儲物箱連蓋及活輪
Hard Pulp Box with Lid and Stocker

15967209 \$280

L38 x D36 x H36cm

內寸：L35.5 x D33 x H31cm

▲10kg



硬質紙儲物箱連蓋
Hard Pulp Box with Lid

15967193 \$180

L25.5 x D36 x H32cm

內寸：L23 x D33.5 x H31cm

▲8kg ◎2

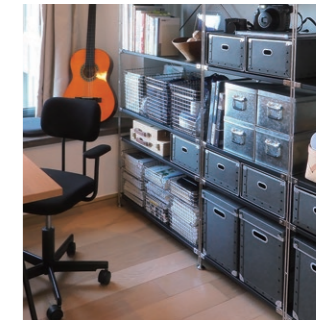

鋼質工具箱 Steel Tool Box

用途廣泛，設計簡潔實用，自然融入生活空間。



鋼質工具箱
Steel Tool Box

37845992 \$180

L38 x D18 x H13cm

▲10kg



37845947 \$200

L38 x D23 x H10cm

▲10kg ◎2



37845831 \$100

L20 x D11 x H6cm

▲1.5kg ◎3



37845886 \$90

L16 x D11 x H6cm

▲1.5kg ◎3



不銹鋼儲物 Stainless Steel Storage

結實耐用且不易生銹，附有手挽方便移動物件。將手挽收於內側便可層疊擺放。

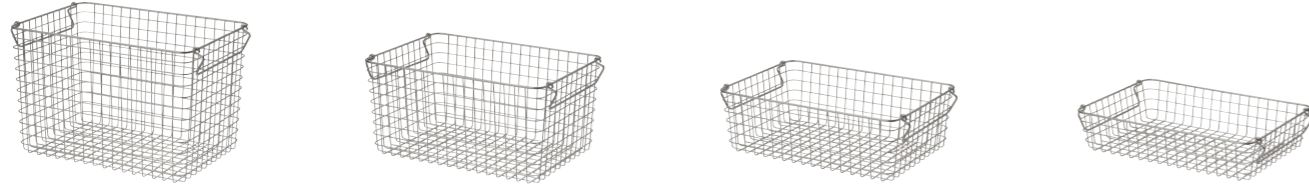

不銹鋼手挽籃
Stainless Steel Wire Basket with Handle

44831502 L37 x D26 x H24cm ▲10kg ◎2 A4	\$220	44831496 L37 x D26 x H18cm ▲5kg ◎2 A4	\$185	44831755 L37 x D26 x H12cm ▲5kg ◎2 A4	\$138	44831748 L37 x D26 x H8cm ▲5kg ◎2 A4	\$128
---	-------	--	-------	--	-------	---	-------

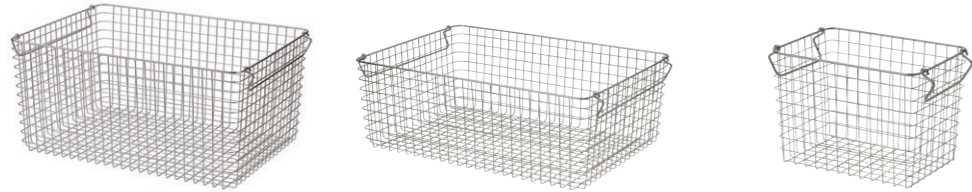

不銹鋼手挽籃
Stainless Steel Wire Basket with Handle

44831526 L51 x D37 x H24cm ▲15kg ◎2	\$328	44831519 L51 x D37 x H18cm ▲10kg ◎2	\$250	44831731 L26 x D18 x H18cm ▲5kg ◎2	\$108
---	-------	---	-------	--	-------



鍍錫儲物 Tin Storage

以建築常用的鍍錫素材製成，堅固且不易生銹。鍍錫儲存盒可疊放使用而不易滑落；手柄位置設有標籤格，方便辨識內存物件。



鍍錫儲存盒 大
Tin Box L

44287897 L L26 x D37 x H24cm	\$150	44287903 M L26 x D37 x H16cm	\$120	44287910 Half L26 x D34 x H8.5cm	\$80
---------------------------------	-------	---------------------------------	-------	-------------------------------------	------



鍍錫儲存盒 小
Tin Box S

44287927 S L19 x D29 x H16cm	\$110	44287934 Half L19 x D27 x H8.5cm	\$85
---------------------------------	-------	-------------------------------------	------



亞加力儲物 Acrylic Storage

採用高透明度的亞加力素材製成，使內存物件一目了然，方便取用。尺寸統一，可自由組合使用，整齊分類存放桌面上的文具及零散小物，增加桌面空間感。



亞加力分隔架
Acrylic Partition Shelf
15919840 \$65
L26 x D17.5 x H16cm



亞加力分隔架
Acrylic Partition Shelf
15919833 \$48
L26 x D17.5 x H10cm



亞加力分隔座 大
Acrylic Divider L
82998214 \$108
L26.8 x D21 x H16cm



亞加力分隔座 小
Acrylic Divider S
82998207 \$95
L13.3 x D21 x H16cm



亞加力儲物架 大
Acrylic Rack L
15296309 \$120
L17.5 x D13 x H14.3cm



亞加力儲物架 小
Acrylic Rack S
15296286 \$90
L8.8 x D13 x H14.3cm



亞加力儲物架
Acrylic Storage Stand
61798233 \$108
L8.7 x D17 x H25.2cm



亞加力三層儲物架
Acrylic 3 Shelf Storage Stand
44089521 \$120
L17.5 x D6.5 x H23cm



亞加力六層儲物盒
Acrylic 6 Drawers Storage Case
37268142 \$190
L8.7 x D17 x H25.2cm



亞加力三層儲物盒
Acrylic 3 Drawers Storage Case
61798202 \$180
L8.7 x D17 x H25.2cm



亞加力一層儲物盒
Acrylic 1 Drawer Storage Case
61798196 \$150
L25.2 x D17 x H8.7cm



亞加力紙巾盒
Acrylic Tissue Box
44510322 \$48
L14 x D11.5 x H7cm



亞加力五層儲物盒
Acrylic 5 Drawers Storage Case
15915491 \$280
L25.5 x D17 x H16cm



亞加力三層儲物盒
Acrylic 3 Drawers Storage Case
15915507 \$200
L25.5 x D17 x H10cm



亞加力展示架連趟門 大
Acrylic Display Case with Sliding Doors L
02856113 \$198
L33.6 x D8.4 x H24.4cm



亞加力展示架連趟門 小
Acrylic Display Case with Sliding Doors S
02856120 \$150
L25.2 x D8.4 x H18.4cm



亞加力可堆疊兩層儲物盒 大
Acrylic Stackable 2-Row Drawer L
82998283 \$180
L25.5 x D17 x H9.5cm



亞加力可堆疊揭蓋式兩層儲物盒 大
Acrylic Stackable 2-Row Drawer with Lid L
82998290 \$180
L25.5 x D17 x H9.5cm



亞加力可堆疊兩層儲物盒
Acrylic Stackable 2-Row Drawer
47380910 \$120
L17.5 x D13 x H9.5cm



亞加力可堆疊揭蓋式兩層儲物盒
Acrylic Stackable 2-Row Drawer with Lid
47380965 \$120
L17.5 x D13 x H9.5cm



絲絨橫向首飾格
Stackable Velour Case for Necklaces
44596531 \$48
L23.5 x D15.5 x H2.5cm



絲絨半橫向首飾格
Stackable Velour Case for Jewelry
44596548 \$48
L23.5 x D15.5 x H2.5cm



絲絨格子首飾格
Stackable Velour Case Grid
44596517 \$48
L15.5 x D12 x H2.5cm



亞加力眼鏡儲物架
Acrylic Stand for Glasses
61174280 \$180
L6.7 x D17.5 x H25cm



亞加力飾物掛架
Acrylic Stand for Jewelry
18958207 \$120
L6.7 x D13 x H25cm



亞加力展開式飾物掛架
Acrylic Double Stand for Jewelry
38671480 \$138
L17.5 x D8.8 x H25cm



絲絨首飾格
Velour Partition
44596562 \$28
L5 x D16.5 x H2cm



絲絨首飾格
Velour Partition
44596586 \$28
L3.7 x D16.7 x H2cm



絲絨首飾格
Velour Partition for Rings
44596579 \$28
L3.7 x D16.7 x H2cm

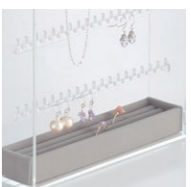



亞加力可堆疊盒 大
Acrylic Stackable Box L
[44089583] \$95
L25.2 x D12.6 x H16cm



亞加力可堆疊盒 中
Acrylic Stackable Box M
[44089576] \$68
L25.2 x D12.6 x H8cm



亞加力可堆疊盒 小
Acrylic Stackable Box S
[82998344] \$55
L25.2 x D12.6 x H4cm



亞加力可堆疊紙巾盒蓋
Cover for Acrylic Stackable Tissue Box
[82998320] \$18
L24.6 x D12cm



亞加力可堆疊抹手紙盒蓋
Cover Acrylic Stackable Paper Tower Box
[82998337] \$20
L24.6 x D12 x H3cm



亞加力分隔座
Acrylic Divider
[02856106] \$20
L5.8 x D8.4 x H5.7cm



亞加力筆筒
Acrylic Pen stand
[82998368] \$12
L5.5 x D4.5 x H9cm



亞加力可堆疊桌上儲物盒 小
Acrylic Stackable Desktop Box S
[02856069] \$16
L8.4 x D8.4 x H3cm



亞加力可堆疊桌上儲物盒 中
Acrylic Stackable Desktop Box M
[02856052] \$22
L8.4 x D8.4 x H6cm



亞加力可堆疊桌上儲物盒 大
Acrylic Stackable Desktop Box L
[02856045] \$28
L8.4 x D8.4 x H9cm



亞加力電話座 小
Acrylic Smartphone Stand S
[02856229] \$58
L8.4 x D8.4 x H9cm



亞加力電話座 大
Acrylic Smartphone Stand L
[02856212] \$78
L16.8 x D8.4 x H9cm



絲絨縱向眼鏡格 大
Stackable Velour Case L for Glasses
[44596739] \$65
L23.5 x D15.5 x H4.7cm



絲絨縱向眼鏡格 小
Stackable Velour Case S for Glasses
[44596715] \$48
L15.5 x D12 x H4.7cm



絲絨橫向手錶格 小
Stackable Velour Case S for Watch
[44596708] \$48
L15.5 x D12 x H4.7cm

PP文件格 PP File Box

可用作整齊存放各種形狀不規則的生活用品，提升空間的統一性。平形款式加配文件格蓋即可層疊使用，令用途更多樣化。



PP直立式文件格 闊形
PP Stand File Box Wide
[44902905] \$55
[44902912] White Gray
L15 x D27.6 x H31.8cm
[A4] [] []



PP直立式文件格
PP Stand File Box
[44902738] \$48
[44902899] White Gray
L10 x D27 x H31.8cm
[A4] [] []



PP文件格 闊形
PP File Box Wide
[44902875] White Gray \$78
L25 x D32 x H24cm



PP半形文件格 闊形
PP File Box Half Wide
[44902882] White Gray \$55
L25 x D32 x H12cm



PP文件格 闊形
PP File Box Wide
[44902806] \$55
[44902813] White Gray
L15 x D32 x H24cm
[A4] []



PP文件格
PP File Box
[44902769] \$45
[44902776] White Gray
L10 x D32 x H24cm
[A4] []



PP半形文件格 闊形
PP File Box Half Wide
[44902783] \$32
[44902790] White Gray
L15 x D32 x H12cm



PP半形文件格
PP File Box Half
[44902745] \$28
[44902752] White Gray
L10 x D32 x H12cm
[]

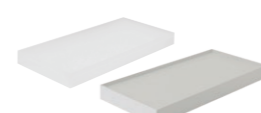

PP文件格蓋
PP File Box Lid
[44902868] L25cm White Gray \$38
[44902820] L15cm \$32
[44902837] L15cm White Gray \$32
[44902844] L10cm \$25
[44902851] L10cm White Gray \$25
[A4] []



PP手提分隔儲物箱
PP Carry Box with Partition
[15915453] \$78
[37035508] White Gray
L15 x D32 x H8cm



PP文件格連手挽
PP File Box with Handle
[38654834] \$85
[38699019] White Gray
L10 x D32 x H28.5cm
[A4] [] []



PP手提文件盒
PP Stand Carry Case
[38699026] \$78
[02815783] White Gray
L28 x D32 x H7cm
[A4] [] []



PP文件格用整理盒
Organizing Box for PP File Box
[82207682] 3pcs \$8
L15cm
[82207699] 3pcs \$8
L15cm



PP儲物用活輪
Castor for PP Storage
[15523788] 4pcs \$38
• 使用後，因應不同種類之PP儲物箱，高度會升高3.8 - 4.2cm。

PP化妝品盛器 PP Makeup Tray

半透明的PP素材有助識別內藏物件，同時便於清潔。款式尺寸統一，配以專用蓋即可層疊擺放，另亦能配合尼龍化妝箱或其他收納用品使用。



PP化妝品盛器
PP Makeup Box

[44310199]	\$28	[37495548]	\$28	[37495555]	\$22	a [37495562]	\$15
L15 x D22 x H21cm		L15 x D22 x H16.9cm		L15 x D22 x H8.6cm		L15 x D22 x H4.5cm	

PP化妝品盛器用蓋 大
Lid for PP Makeup Box L

b [82576153]	\$15
L15.7 x D23.2 x H2cm	



PP化妝品盛器 橫向式
PP Makeup Box Horizontal

[37495586]	\$18	c [37497764]	\$12
L15 x D11 x H8.6cm		L15 x D11 x H4.5cm	

PP化妝品盛器用蓋 小
Lid for PP Makeup Box S

d [82576160]	\$10
L11.7 x D15.7 x H2cm	



PP化妝用具筒
PP Makeup Tools Stand

[37497672]	\$10
L7.1 x D7.1 x H10.3cm	



PP棉花棒盒
PP Cotton Buds Case

[37497665]	\$15
L10.7 x D7.2 x H7.7cm	

小物整理用品 Small Item Storage

可單獨或配合無印良品家具及收納用品使用，幫助劃分桌面或抽屜空間，令小物收納更井然有序。



PP桌面整理格
PP Desk Organizer

[18421541]	\$10	[18421558]	\$15	[18421565]	\$12	[18421572]	\$15
L10 x D10 x H4cm		L10 x D20 x H4cm		L6.7 x D20 x H4cm		L13.4 x D20 x H4cm	



PP儲物盒
PP Arrangement Box

[12057093]	\$8	[12057109]	\$12	[12057116]	\$15	[12057123]	\$12
L8.5 x D8.5 x H5cm		L8.5 x D25.5 x H5cm		L17 x D25.5 x H5cm		L11.5 x D34 x H5cm	



PP六層收納抽屜
PP 6-Drawer Storage Box

[61154909]	\$198
L11 x D24.5 x H32cm	

PP三層收納抽屜
PP 3-Drawer Storage Box

[61164458]	\$165
L11 x D24.5 x H32cm	

PP三層收納抽屜分格
Divider for PP 3-Drawer Storage Box

[18657063]	\$12
L9.9 x D9.1 x H0.3cm	



鋼書座
Steel Divider

[82603057]	\$38	[82603064]	\$28	[82603071]	\$18
L16 x D15 x H21cm		L12 x D12 x H17.5cm		L10 x D8 x H10cm	



聚苯乙烯文件分隔座
Styrene Divider

[02856410]	\$70	[02856427]	\$50
L27 x D21 x H16cm		L21 x D13.5 x H16cm	

磁石貼
Magnet Bar

[38996460]	White Gray	\$15
L19 x D0.4 x H3cm		

• 可將文件格用小物座勾掛於磁石貼上

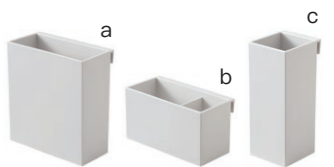

文件格用小物座
PP File Box Pocket

a [38996477]	White Gray	\$15
L9 x D4 x H10cm		
b [38996491]	White Gray	\$12
L9 x D4 x H5cm		
c [38996484]	White Gray	\$12
L4 x D4 x H10cm		

硬質紙板儲物 Cardboard Storage

只需簡單組裝便可使用；不使用時可摺疊收藏，不佔空間。用畢後可作回收處理，關顧環境。



硬質紙板文件格
Cardboard File Box

02081355 5pcs \$72
L10 x D32 x H25cm



硬質紙板直立式文件格
Cardboard Stand File Box

02081348 5pcs \$72
L10 x D28 x H32cm



硬質紙板文件格
Cardboard File Box

38708643 5pcs \$72
L10 x D32 x H25cm



硬質紙板直立式文件格
Cardboard Stand File Box

38708636 5pcs \$72
L10 x D28 x H32cm



硬質紙板文件格蓋
Lid For Cardboard File Box

82913958 \$8



硬質紙板文件格蓋
Lid For Cardboard File Box

82913965 \$8



硬質紙板文件格蓋
Lid For Cardboard File Box

44076729 \$12

硬質紙板文件格
Cardboard file box
82913934 \$12
L10 x D1 x H2cm

硬質紙板文件格
Cardboard file box
82913941 \$15
L15 x D1 x H2cm

硬質紙板文件格
Cardboard File Box
44076712 \$20
L25 x D1 x H2cm



硬質紙板儲物盒
Cardboard Storage Box

82913972 \$72
L11 x D24 x H31.6cm



硬質紙板文件格連蓋
Cardboard File Box with Lid

44312247 \$32
L25 x D32 x H12.5cm



硬質紙板文件格連蓋
Cardboard File Box with Lid

44312261 \$35
L25 x D32 x H25cm

MDF儲物 MDF Storage

以木製纖維作素材，堅固且不易彎曲，耐用性高；配以和諧色調，自然融入生活空間。



木製MDF直立式文件架
Wooden Stand file box

44310205 \$148
L9.2 x D27.5 x H32cm



木製MDF直立式文件架
Wooden MDF File Stand

82603354 \$138
L8.4 x D17 x H25.2cm



木製MDF六層儲物盒
Wooden MDF 6 Drawers Storage

82603330 \$238
L8.4 x D17 x H25.2cm



木製MDF三層儲物盒
Wooden MDF 3 Drawers Storage

82603323 \$200
L8.4 x D17 x H25.2cm



木製MDF五層儲物盒
Wooden MDF 5 Layers Storage

44310212 \$138
L9.2 x D12.6 x H25.2cm



木製MDF一層儲物盒
Wooden MDF 1 Drawer Storage

82603316 \$138
L25.2 x D17 x H8.4cm



木製MDF文件架
Wooden MDF Letter Tray

82603347 \$188
L32 x D24 x H10.5cm
©3
A4



木製MDF兩層儲物架
Wooden Storage tray 2 drawers

44310229 \$188
L25.2 x D17 x H12.6cm



木製MDF信封架
Wooden Letter stand

44310243 \$55
L6.3 x D12.6 x H14.7cm



木製MDF儲物盒
Wooden Tool box

44310236 \$138
L16.8 x D16.8 x H12.6cm



木製MDF桌上儲物盒
Wooden desktop item Tool box

44310267 \$88
L25.2 x D6 x H9cm



木製MDF紙巾盒
Wooden MDF Tissue Case

82603361 \$168
L26.5 x D13.5 x H7.2cm



木製MDF文件格
Wooden document holder

44310274 \$98
L16.8 x D16.8 x H8.4cm



木製MDF展示架連趟門
Wooden display case With sliding doors

44310250 \$188
L25.2 x D8.4 x H25.2cm



木製展示櫃亞加力分隔板
Wooden display case Acrylic divider

12013440 \$15
L23.5 x D6.45 x H0.4cm



低噪音風扇 Circulator Fan

低噪音風扇改善室內空氣循環，將空氣帶到室內每個角落，享受清新涼快的家居環境。



加強空氣循環

長距離直線送出強風，促進空氣流通以降低室內溫差，令室內舒適涼快。

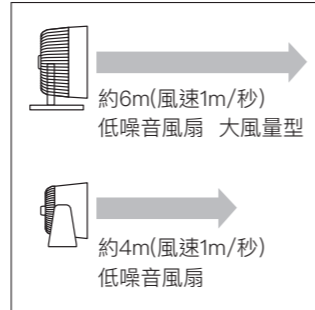

輔助冷氣使用

將風扇放置在與冷氣同一面牆壁的另一角落，調較至45度傾斜並面向房間中心，可把聚集在地面的冷空氣傳送至房間各處，提高冷氣效能，節省用電。

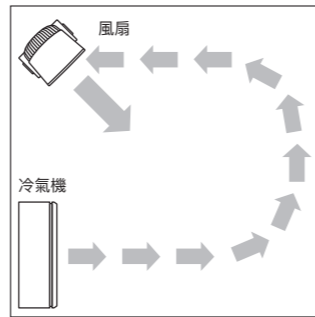

低噪音風扇 大風量型

Low Noise Circulator Fan Large Air Volume Type

[38309833] \$590

Dia33.1 x D25.5 x H37.5cm

型號：AT-CF26RHK-W

重量：4kg

電源：AC220V 50Hz

風量(m³/min)：強22.5•中17.1•弱6

3段風速調節，風向調整角度為0-90度，可分5階段調整角度。產生大風量同時保持寧靜的運轉音量。可拆式外蓋，方便清潔扇葉。



低噪音風扇

Low Noise Circulator Fan

[02435752] \$490

L28.5 x D21.4 x H29.7cm

型號：MJ-CF18UK-W

重量：2kg

電源：AC220V 50Hz

風量(m³/min)：強9.7•中8.1•弱5.5

3段風速調節，風向調整角度為0-90度，可分5階段調整角度。細心設計扇葉，確保充足風量及寧靜運轉。

家居電器 Home Appliances

擁有基本功能並可長久使用，以柔和簡潔的型態自然融入家居，與其他日用品和諧協調，成為生活的一部分。



香薰噴霧器 大 Aroma Diffuser L

[38907329] \$680

Dia16.8 x H12.1cm

重量：520g

消耗電力：18W

輸入：AC100-240V 50/60Hz

電線：1.7m

容量：350ml

適用距離：20-25平方米

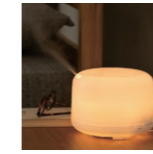

香薰噴霧器 小 Aroma Diffuser S

[21374953] \$450

Dia8 x H14cm

重量：220g

消耗電力：12W

輸入：AC100-240V 50/60Hz

電線：1.7m

容量：100ml

適用距離：12平方米



便攜式香薰器 Portable Aroma Diffuser

[82506808] \$280

L7.5 x D7.5 x H3.7cm

重量：約72g (包括鋰離子充電電池)

適用距離：約0.5米

充電時間：每次約3.5小時

配件：專用USB線、專用軟墊袋

便攜式香薰器棉墊替換配件

Refill For Portable Aroma Diffuser

[02480295] \$45

棉墊x5、棉墊支架x1、棉墊移除專用叉



電子磅

Health Meter

[38969693] \$380

L26.5 x D20.8 x H3.5cm

重量：750g

附電池 AA x 2



USB充電式手提風扇

USB Rechargeable Compact Handheld Fan

[12057949] \$88

L6.8 x D3.3 x H14.8cm

重量：約92g (包括充電電池)

消耗電力：7W

充電時間：每次約3.5小時

電線：約54cm

內置充電電池：DC3.7V 1400mAh



太陽能電子廚用秤 Solar Cooking Scale

[18919321] White \$350

L12.2 x D20 x H4cm

最高量度重量：2KG

最小表示：0-500g/1g; 500-1000g/2g;

1000-2000g/5g

10分鐘自動關機



壁掛式CD機連收音機 Wall Mounted CD Player

[76475606] White \$1380

L17.2 x D4.1 x H17.2cm

FMI收音機：可自動接收87.5MHz-108MHz頻度，

接收天線可收藏於機背。

CD-R播放：支援以MP3 / WMA錄製的CD-R，

更可重複播放。

配件：遙控器、AC轉接器、掛牆板、石膏板用的針套裝、木螺絲x4

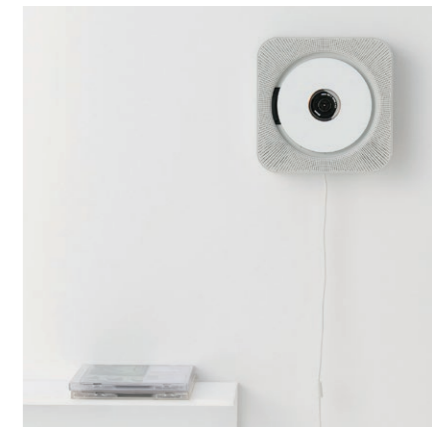

時鐘 Clock

備有指針及電子款式，清晰顯示時間，部分款式更附溫度及濕度計功能。



車站時鐘
Station Clock
[82928501] White \$580
L31.5 x D4.3 x H22.5cm
附電池 AA x 1

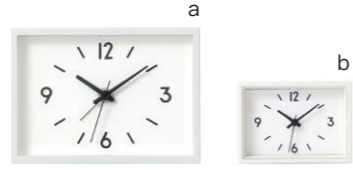

車站響鬧時鐘
Station Alarm Clock
a [38673576] White \$250
L12.6 x D4 x H9cm
附電池 AA x 1

迷你車站時鐘
Mini Station Clock

b [44275771] White \$150
L7.1 x D2.05 x H5.05cm
附電池 LR44 x 1

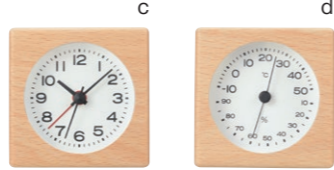

樺木鬧鐘
Beech Wood Alarm Clock
c [15832682] Natural \$300
L7 x D4.1 x H7cm
附電池 AA x 1

樺木溫度 / 濕度計
Beech Wood Thermometer / Hygrometer

d [15832699] Natural \$300
L7 x D4.3 x H7cm



掛牆鐘 大
Wall Clock L
[44275689] White \$320
[44275696] Black
[44275726] Natural \$550
[44275733] Dark Brown
Dia26.4 x 4.5cm
附電池 AA x 1

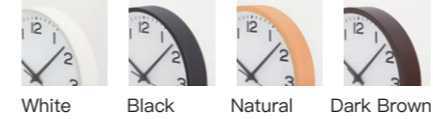

掛牆鐘連座檯架 小
Wall Clock with Stand S
[44275702] White \$180
[44275719] Black
Dia12.4 x 4.4cm
附電池 AA x 1



座檯架 掛牆鐘 / CD機用
Stand for Wall Clock & CD Player
[37494541] Silver \$120
L10 x D15 x H28cm



電子響鬧時鐘 中
Digital Alarm Clock M
[15831999] White \$450
[15832002] Black
L18 x D5.2 x H8.8cm
附電池 AA x 2



電子響鬧時鐘 小
Digital Alarm Clock S
[15832019] White \$350
[15832026] Black
L12 x D4.8 x H6.1cm
附電池 AA x 2



電子響鬧時鐘
Digital Clock with Loud Alarm
[44581483] White \$350
L14.8 x D6.4 x H5.9cm
附電池 AA x 2



布穀鳥時鐘
Cuckoo Clock
[15832606] \$550
L25.5 x D12.5 x H26.7cm
附電池 AA x 1



迷你公園時鐘
Mini Park Clock
[44275740] White \$135
[44275757] Black
L5.5 x D5.5 x H18.2cm
附電池 LR44 x 1



電子計時鐘
Digital Timer Clock
[37494527] White \$165
L8 x D2 x H3.6cm
附電池 CR2032 x 1



電子溫度 / 濕度計
Digital Thermometer / Hygrometer
[15832392] White \$165
[15832408] Black
L5.5 x D5.3 x H9.1cm
附電池 CR2032 x 1



顧客購買大型家具須知

1. 本資料適用於大型包裝而造成運送困難的家具商品，包括特大雙人床褥、真皮梳化2.5座位或3座位等。如果顧客有需要知悉其他商品的運送要求，請向店員查詢。顧客應確保進出送貨地址有適當的通道可供送貨，因此建議顧客訂購前應量度運送通道的空間及了解環境狀況。搬運空間尺寸請參閱下列參考資料。
2. 以下參考資料為一般搬運準則，並假設搬運的通道沒有樑柱、扶手欄杆、燈具等可能阻礙的物件。因應實際場所環境的不同，運送通道的要求可能會有不同。送貨服務會按照“送貨服務條款及細則”提供。
3. 如顧客的送貨地址是不能以升降機直達，顧客需在要求送貨服務時通知本公司，並支付有關上樓搬運費。如因沒有適當的通道而未能送貨，本公司將與顧客聯絡安排改期，及/或收取有關之額外費用。如因此造成任何送貨延誤或未能送貨，或按顧客指示進行運貨時造成任何損毀，本公司恕不負上任何責任。
4. 如顧客因上述運送問題而要求退貨或換貨，顧客須支付退回商品的送貨費及其他相關額外費用，而退回的商品必須維持原狀和未曾被使用，及附有原有包裝，並按照“商品退換服務條款及細則”處理。惟本公司是否接納有關要求有最終決定權。

參考資料

大型商品	商品外箱大小
橡木長檯	L226 x W98 x H13cm
IDÉE DIMANCHE 真皮梳化	L214 x W95 x H76cm
真皮梳化 3座位	L230 x W95 x H57cm
真皮梳化 2.5座位	L205 x W100 x H67cm
特大雙人床褥	L197 x W164 x H22cm

一般運送要求

• 使用電梯搬運

建議顧客留意是否符合電梯門高度(A)及電梯內深度(B)兩個尺寸，並注意電梯外大堂空間是否足夠搬運家具及進入電梯。

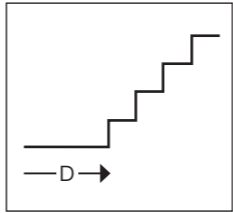
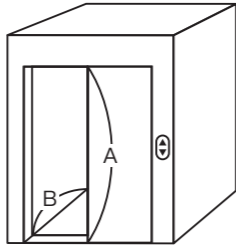

• 使用樓梯搬運

i) 直線梯：基本上可以搬入

ii) 迴旋梯：需注意樓梯距天花板高度及樓梯平台深度 (D)

送貨收費及服務條款



瀏覽詳情

家具保養建議

木製家具

- 因採用天然木材關係，每件家具之木紋及顏色可能略有不同。
- 天然木材的顏色及木紋有機會隨時間改變。
- 木製家具適用於空氣流通、乾爽、氣溫和濕度穩定及不容易受陽光直接照射的空間，以免木材出現裂紋或發霉情況。
- 木製家具可以使用乾布拭抹作日常清潔。如家具表面有頑固污漬，可以乾布沾上稀釋後的中性清潔劑輕輕拭擦，再以乾布抹乾。

金屬製家具及配件

- 金屬製家具適用於乾爽、氣溫和濕度穩定及不容易受陽光直接照射的空間，以免金屬出現銹蝕或金屬疲勞情況。
- 小心避免刮花金屬製家具或配件的表面，因會破壞金屬表面的保護層並加速氧化所導致的銹蝕現象。
- 金屬製家具的日常清潔只需以乾布拭抹便可。

Information for Large Furniture Purchase

1. The information is applicable to furniture with large packing size which may have difficulty for delivery, including Mattress – Queen, 2.5 seats and 3 seats Leather Sofa. Please check with our staff about the delivery requirement for any merchandises not listed below (if necessary). Customer shall ensure adequate access at the delivery address so customer is advised to measure the space and check the condition of the access prior to purchase with reference to the delivery requirement for large furniture packing as stated below.
2. The below delivery requirement is a general access requirement only assuming that there is no obstacle, like pillar, handrail, lightings, etc. along the access. The delivery requirements may vary subject to the actual environment factor. The delivery service shall be provided according to our "Terms and Conditions for Delivery Service".
3. Customer shall notify us at time of requesting delivery service if the delivery address cannot be accessed by elevator and a labour charge shall be imposed. If the merchandise cannot be delivered at the time of arrival due to access problem, we may reschedule the delivery and/or charge customer any extra costs / charges arising therefrom. We shall have no liability from such delivery failure or delay or any loss and damage arising from the delivery as per Customer's instruction.
4. If Customer requests any return or exchange of merchandise due to the such access problem, customer shall bear delivery charge and any extra charges for return delivery and the merchandise must be returned to us in its original and unused condition and with original packing and subject to our “Goods Return and Exchange Terms and Conditions”. We have the final decision on whether to accept such request.

Reference

Large Furniture	Packing Size
Oak Wood Long Table	L226 x W98 x H13cm
IDÉE DIMANCHE Leather Sofa	L214 x W95 x H76cm
Leather Sofa 3 Seats	L230 x W93 x H57cm
Leather Sofa 2.5 Seats	L205 x W100 x H67cm
Mattress – Queen	L197 x W164 x H22cm

General Delivery Requirement

• Access by Elevator

Customer is advised to ensure the height of elevator door (A) and the depth of elevator (B). The lobby and path should have adequate access for the merchandizes.

• Access by Stairs

i) Straight line: Basically it can be accessed.

ii) With Turning Corner: Customer is advised to ensure the height between stairs, ceiling and the depth of turning corner (D).

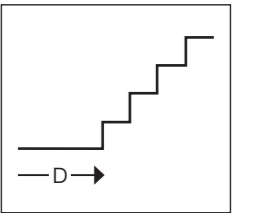
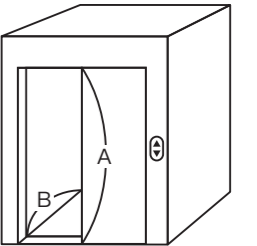

Delivery Charges and Service Terms & Condition



Please scan for details

Recommendations on Furniture Maintenance

Wooden Furniture

- The colour and pattern of the furniture may be slightly different because of the natural wood.
- The colour and pattern of natural wood may change as time goes by.
- Wooden furniture shall be used in room with good ventilation, dry, stable temperature and humidity and away from sunlight to avoid cracking or mold growth.
- Wooden furniture can be cleaned with dry cloth daily. Use a cloth with diluted neutral cleaning agent to remove obstinate stain on the furniture surface, and dry with cloth after cleaning.

Metallic Furniture & Accessories

- Metallic furniture shall be used in dry room with stable temperature and humidity and away from sunlight to avoid corrosion or metal fatigue.
- Please be aware of scratching on metal surface to minimize metal corrosion.
- Metallic furniture can be cleaned with dry cloth daily.



家具配置諮詢服務 Interior Advisory Service

從整理收納，以至更有效善用空間的家具配置建議，建立整潔舒適的生活環境。



整理收納

透過洽談了解現況，根據物件用途及使用頻度，分享收納方法及儲物用品選擇建議。



家具選擇

根據生活型態及家居間隔，由商品選擇以至配置方法，提供實用家具組合建議。

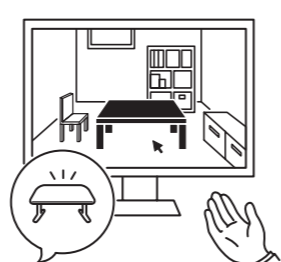

空間配搭

以簡單電腦模擬示範，確切掌握家具色調與空間配搭的效果，建立自然和諧的空間。

企業客戶服務 Corporate Service

根據您的業務需要，從工作用品採購以至辦公室家具配置，提供合適規劃與協助，讓舒適生活的理念延伸至日常工作之中。即日起企業客戶可於網上訂購所需，令採購更便捷。



文具及收納用品訂購

企業客戶凡原箱訂購「文具·收納」目錄內之商品，可專享優惠。



其他商品訂購

逾7000款無印良品商品供訂購，應付日常營運、企業活動等多元化業務所需。

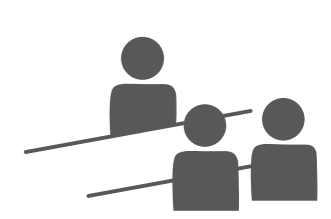

辦公室家具配置

提供辦公室家具及收納組合建議，活用有限空間，建立舒適的工作環境。



無印良品家具配置顧問
配有專用名牌以資識別



瀏覽詳情

無印良品企業客戶服務部
電話：3501 4688



瀏覽詳情



請即下載 MUJI passport，專享會員優惠。
Download MUJI passport now to enjoy member privileges.



本服務及優惠對象只限於 MUJI passport (香港版) 用戶。
This service and related promotions are offered for MUJI passport (Hong Kong version) users only.

顧客服務 Customer Service 2694 9309

www.muji.com/hk/

所有價格均以港幣標示。

Prices are shown in Hong Kong Dollar.

所有商品價格不包括送貨費、安裝費或其他服務費用。

Delivery charge, assembly charge and other service charges are excluded in the selling prices.

所有商品資料、價格及貨存以店內陳列為準。

All item information, selling prices and inventory are subject to in-store display.

部分商品只限於個別店鋪發售。

Some items are available at designated stores only.

圖片只供參考。

Images are for reference only.

如訂購之商品因缺貨或停產而未能提供，有關訂單將會取消及全數退回已付之款項。

If items ordered are out of stock or discontinued, orders will be cancelled with full refund.

家具製造過程可能會造成不超過2厘米之尺寸差異(長度、闊度、高度或直徑)。

No more than 2cm variance in dimension (length, width, height or diameter) may occur during manufacturing process.

2023年5月版

© MUJI (Hong Kong) Company Limited. All rights reserved.